

content

test couplings



series M16x2

- valve function by ball – zinc nickel, transparent
- valve function by piston – zinc nickel, transparent
- valve function by piston – for inert gases
- connectors and adaptors – zinc nickel, transparent
- valve function by piston – stainless steel

page f. 2
page f. 8
page f. 14
page f. 19
page f. 24



series M16x1,5

- valve function by ball – zinc nickel, black
- valve function by piston – zinc nickel, black
- valve function by piston – stainless steel (upon request)
- connectors and adaptors – zinc nickel, black

page f. 29
page f. 34
page f. 39



series S12x1,5

- valve function by piston – zinc nickel, transparent
- connectors and adaptors – zinc nickel, transparent

page f. 41
page f. 45



series Steck

- valve function by ball – zinc nickel, transparent
- connectors and adaptors – zinc nickel, transparent

page f. 47
page f. 50



test box

- Spradow Test Box with 2 and more pressure gauges
Standard equipment or according to your specifications

page f. 52



pressure gauges

- NG63, G1/4 A bottom, different pressure stages
- NG63, 1/4 NPT bottom, different pressure stages

page f. 54
page f. 54



hoses and connectors

- hose material
- hose end fittings

page f. 55
page f. 57

adaptor and accessories

- fittings BE and GE as single parts
- caps and weld-on nipple

page f. 60
page f. 61

annex

- port connection and seals
- definition of the hose assembly length

page f. 62
page f. 63

Application:

Spradow test couplings are applied for the monitoring and control pressure as well as the ventilation. The advantages of this system are - among other - connection at system pressure level, the easy connection to measurement control and switching devices, the leakproof connection and the integrated vibration security of the metal cap.

Media:

Hydraulic oils and mineral based fluids.
(Please check compatibility of seal material.)

Materials:

Metal parts: Steel, Stainless steel upon request

Seals: NBR (-20 °C to +100 °C)
FKM (-20 °C to +200 °C)
EPDM (-40 °C to +150 °C)

Hose: Polyamide (-35 °C to +100 °C)

Surface:

Zinc nickel, transparent, CrVI-free.

Pressure:

Maximum working pressure (PN) of the test couplings - 630 bar, at 4-fold security. Connection under pressure up to 400 bar. For the union pieces please observe the instructions given by the corresponding producer.



design types of caps

type B (round)	type A (universal)	type A (universal) plastic
standard: incl. vibration security		(temperature range -20°C to +100°C)

port connection and seals

type 1	type 2	type 3	type 4	type 5	type 6
Design types of port connection and seals please see annex.					

test coupling series M16x2 – valve function by ball

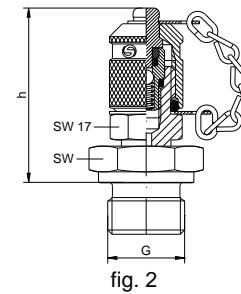
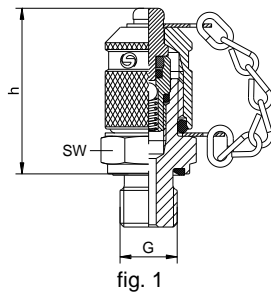

G	PN	SW	h	fig.	sealing	part number (NBR)	part number (FKM)
M8x1	250	17	38	1	o-ring type 1	1-906-20-21-600-CF	1-906-20-22-600-CF
M8x1		17	38	1	metallic sealing type 2	1-906-20-30-600-CF	1-906-20-32-600-CF
M10x1	630	17	38	1	o-ring type 1	1-906-22-21-600-CF	1-906-22-22-600-CF
M10x1	400	17	38	1	metallic sealing type 2	1-906-22-30-600-CF	1-906-22-32-600-CF
M10x1	400	17	39	1	soft sealing type 3	1-906-22-11-600-CF	1-906-22-12-600-CF
M10x1		17	38	1	metallic sealing type 6	1-906-22-40-600-CF	1-906-22-42-600-CF
M10x1,25		17	38	1	o-ring type 1	1-906-49-21-600-CF	1-906-49-22-600-CF
M10x1,25		17	38	1	soft sealing type 3	1-906-49-11-600-CF	1-906-49-12-600-CF
M12x1,5	630	17	38	1	metallic sealing type 2	1-906-23-30-600-CF	1-906-23-32-600-CF
M12x1,5	630	17	39	1	soft sealing type 3	1-906-23-11-600-CF	1-906-23-12-600-CF
M14x1,5	630	19	37	1	metallic sealing type 2	1-906-24-30-600-CF	1-906-24-32-600-CF
M14x1,5	630	19	37	1	soft sealing type 3	1-906-24-11-600-CF	1-906-24-12-600-CF
M14x1,5	630	19	38	1	o-ring type 5	1-906-24-61-600-CF	1-906-24-62-600-CF
M16x1,5	630	22	37	1	metallic sealing type 2	1-906-25-30-600-CF	1-906-25-32-600-CF
M16x1,5	630	22	37	1	soft sealing type 3	1-906-25-11-600-CF	1-906-25-12-600-CF
M18x1,5		24	39	1	metallic sealing type 2	1-906-26-30-600-CF	1-906-26-32-600-CF
M18x1,5		24	39	1	soft sealing type 3	1-906-26-11-600-CF	1-906-26-12-600-CF
M20x1,5		27	39	1	metallic sealing type 2	1-906-51-30-600-CF	1-906-51-32-600-CF
M20x1,5		27	39	1	soft sealing type 3	1-906-51-11-600-CF	1-906-51-12-600-CF
M22x1,5		27	39	1	metallic sealing type 2	1-906-27-30-600-CF	1-906-27-32-600-CF
M22x1,5		27	39	1	soft sealing type 3	1-906-27-11-600-CF	1-906-27-12-600-CF
M26x1,5		32	49	2	metallic sealing type 2	1-911-52-30-600-CF	1-911-52-32-600-CF
M27x2		36	49	2	metallic sealing type 2	1-911-53-30-600-CF	1-911-53-32-600-CF
M33x2		41	49	2	metallic sealing type 2	1-911-54-30-600-CF	1-911-54-32-600-CF
M42x2		50	50	2	metallic sealing type 2	1-911-55-30-600-CF	1-911-55-32-600-CF
M48x2		60	50	2	metallic sealing type 2	1-911-56-30-600-CF	1-911-56-32-600-CF
G 1/8	400	17	38	1	metallic sealing type 2	1-906-28-30-600-CF	1-906-28-32-600-CF
G 1/8	400	17	39	1	soft sealing type 3	1-906-28-11-600-CF	1-906-28-12-600-CF
G 1/4	630	19	37	1	metallic sealing type 2	1-906-29-30-600-CF	1-906-29-32-600-CF
G 1/4	630	19	37	1	soft sealing type 3	1-906-29-11-600-CF	1-906-29-12-600-CF
G 1/4		19	37	1	metallic sealing type 6	1-906-29-40-600-CF	1-906-29-42-600-CF
G 3/8	630	22	37	1	metallic sealing type 2	1-906-30-30-600-CF	1-906-30-32-600-CF
G 3/8	630	22	37	1	soft sealing type 3	1-906-30-11-600-CF	1-906-30-12-600-CF
G 1/2		27	39	1	metallic sealing type 2	1-906-31-30-600-CF	1-906-31-32-600-CF
G 1/2	630	27	39	1	soft sealing type 3	1-906-31-11-600-CF	1-906-31-12-600-CF
G 3/4		32	40	1	metallic sealing type 2	1-906-32-30-600-CF	1-906-32-32-600-CF
G 1		41	48	2	metallic sealing type 2	1-911-57-30-600-CF	1-911-57-32-600-CF
G 1 1/4		50	50	2	metallic sealing type 2	1-911-58-30-600-CF	1-911-58-32-600-CF
G 1 1/2		60	50	2	metallic sealing type 2	1-911-59-30-600-CF	1-911-59-32-600-CF
Rk 1/8*	400	17	36	1	thread type 4	1-906-33-00-600-CF	1-906-33-02-600-CF
Rk 1/4*	630	17	35	1	thread type 4	1-906-34-00-600-CF	1-906-34-02-600-CF
Rk 3/8*		19	35	1	thread type 4	1-906-35-00-600-CF	1-906-35-02-600-CF
5/16-24 UNF	400	17	38	1	o-ring type 5	1-906-38-30-600-CF	1-906-38-32-600-CF
7/16-20 UNF	630	17	38	1	o-ring type 5	1-906-39-30-600-CF	1-906-39-32-600-CF
1/2-20 UNF	630	17	38	1	o-ring type 5	1-906-61-30-600-CF	1-906-61-32-600-CF
9/16-18 UNF	630	19	38	1	o-ring type 5	1-906-40-30-600-CF	1-906-40-32-600-CF
3/4-16 UNF	630	27	40	1	o-ring type 5	1-906-41-30-600-CF	1-906-41-32-600-CF
1/8 NPT	400	17	36	1	thread type 4	1-906-43-00-600-CF	1-906-43-02-600-CF
1/4 NPT	630	17	35	1	thread type 4	1-906-44-00-600-CF	1-906-44-02-600-CF
3/8 NPT		19	36	1	thread type 4	1-906-45-00-600-CF	1-906-45-02-600-CF
1/2 NPT		22	37	1	thread type 4	1-906-46-00-600-CF	1-906-46-02-600-CF

For metal cap type A (universal) with vibration security, replace 600 by

590

590

For metal cap type B (round) **without vibration security**, replace 600 by

020

020

For metal cap type A (universal) **without vibration security**, replace 600 by

010

010

For yellow plastic cap type A (universal) **without vibration security**, replace 600 by

100

100

*acc. DIN3858

Other dimensions on request. We reserve the right to change the technical performance. All dimensions in mm.

fitting with test coupling series M16x2 – valve function by ball

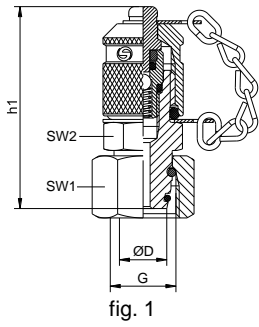

fig. 1

type DKO

test coupling with 24° taper adapter

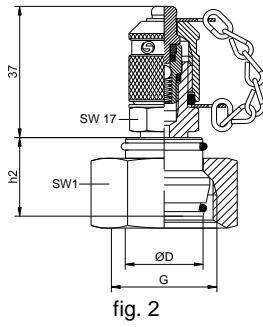

fig. 2

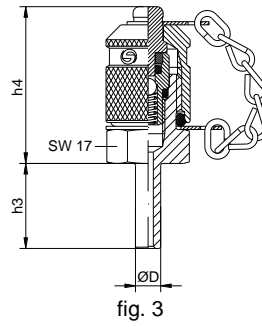

fig. 3

typ BE

test coupling for compression ring fittings

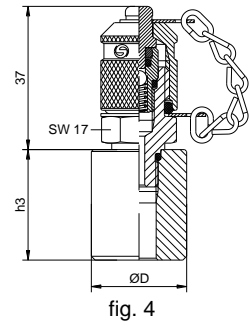

fig. 4

type	PN	tube ØD	h1	h2	h3	h4	SW1	SW2	G	type DKO part number	fig.	type BE part number	fig.
L	315	6	53	-	20	39	14	17	M12x1,5	1-908-00-20-600-CF	1	1-909-00-00-601-CF	3
		8	53	-	20	39	17	17	M14x1,5	1-908-02-20-600-CF	1	1-909-02-00-601-CF	3
		10	50	-	22	37	19	17	M16x1,5	1-908-04-20-600-CF	1	1-909-04-00-601-CF	3
		12	50	-	22	37	22	17	M18x1,5	1-908-06-20-600-CF	1	1-909-06-00-601-CF	3
	160	15	51	-	22	37	27	19	M22x1,5	1-908-09-20-600-CF	1	1-909-09-00-601-CF	3
		18	-	22	28	-	32	-	M26x1,5	1-908-11-00-600-CF	2	1-909-11-00-601-CF	4
		22	-	22	30	-	36	-	M30x2	1-908-13-00-600-CF	2	1-909-13-00-601-CF	4
		28	-	24	32	-	41	-	M36x2	1-908-15-00-600-CF	2	1-909-15-00-601-CF	4
S	630	35	-	27	42	-	50	-	M45x2	1-908-17-00-600-CF	2	1-909-17-00-601-CF	4
		42	-	28	45	-	60	-	M52x2	1-908-19-00-600-CF	2	1-909-19-00-601-CF	4
		6	54	-	20	39	17	17	M14x1,5	1-908-01-20-600-CF	1	1-909-00-00-601-CF	3
	400	8	51	-	20	39	19	17	M16x1,5	1-908-03-20-600-CF	1	1-909-02-00-601-CF	3
		10	51	-	22	37	22	17	M18x1,5	1-908-05-20-600-CF	1	1-909-04-00-601-CF	3
		12	51	-	22	37	24	17	M20x1,5	1-908-07-20-600-CF	1	1-909-06-00-601-CF	3
315	14	53	-	22	37	27	19	M22x1,5	1-908-08-00-600-CF	1	1-909-08-00-601-CF	3	
	16	-	20	28	37	30	-	M24x1,5	1-908-10-00-600-CF	2	1-909-10-00-601-CF	3	
	20	-	25	30	-	36	-	M30x2	1-908-12-00-600-CF	2	1-909-12-00-601-CF	4	
		25	-	27	36	-	46	-	M36x2	1-908-14-00-600-CF	2	1-909-14-00-601-CF	4
		30	-	29	41	-	50	-	M42x2	1-908-16-00-600-CF	2	1-909-16-00-601-CF	4
		38	-	32	48	-	60	-	M52x2	1-908-18-00-600-CF	2	1-909-18-00-601-CF	4

For metal cap type A (universal) with vibration security
 For metal cap type B (round) **without vibration security**
 For metal cap type A (universal) **without vibration security**
 For yellow plastic cap type A (universal) **without vibration security**
 Design with sealings made of FKM

replace 600 by 590
 replace 600 by 020
 replace 600 by 010
 replace 600 by 100
 replace 20 by 22
 or replace 00 by 02

replace 601 by 591
 replace 601 by 021
 replace 601 by 011
 replace 601 by 101
 replace 00-601 by 02-601

90° fitting type BE with test coupling Series M16x2 – valve function by ball

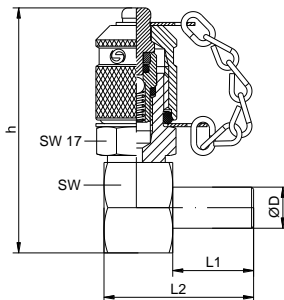

tube ØD	L1	L2	SW	h	part number (NBR)	part number (FKM)
8	20	37	22	59	1-980-03-60-080-CF	1-980-03-60-081-CF
10	20	37	22	59	1-980-05-60-120-CF	1-980-05-60-121-CF

For metal cap type A (universal) with vibration security replace 60 by 59
 For metal cap type B (round) **without vibration security** replace 60 by 02
 For metal cap type A (universal) **without vibration security** replace 60 by 01
 For yellow plastic cap type A (universal) **without vibration security** replace 60 by 10

Other dimensions on request. We reserve the right to change the technical performance. All dimensions in mm.

fitting with test coupling series M16x2 – valve function by ball

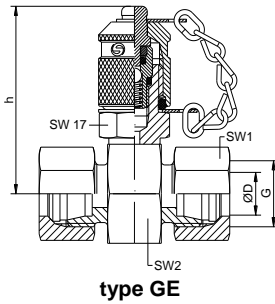

type GE

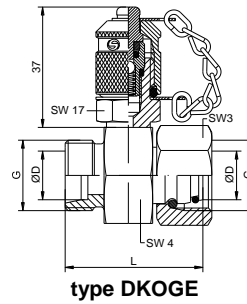

type DKOGE

type	PN tube ØD	G	SW1	SW2	h	L	SW3	SW4	type GE part number	type DKOGE part number	
L	315	6	M12x1,5	14	22	48	43	14	24	1-910-00-00-600-CF	1-910-20-00-601-CF
		8	M14x1,5	17	24	49	43	17	24	1-910-02-00-600-CF	1-910-22-00-601-CF
		10	M16x1,5	19	24	49	45	19	24	1-910-04-00-600-CF	1-910-24-00-601-CF
	160	12	M18x1,5	22	27	51	41	22	27	1-910-06-00-600-CF	1-910-26-00-601-CF
		15	M22x1,5	27	30	53	43	27	30	1-910-09-00-600-CF	1-910-29-00-601-CF
		18	M26x1,5	32	32	53	54	32	32	1-910-11-00-600-CF	1-910-31-00-601-CF
		22	M30x2	36	36	55	57	36	36	1-910-13-00-600-CF	1-910-33-00-601-CF
		28	M36x2	41	41	58		upon request		1-910-15-00-600-CF	1-910-35-00-601-CF
		35	M45x2	50	46	60		upon request		1-910-17-00-600-CF	1-910-37-00-601-CF
S	630	42	M52x2	60	55	65		upon request	1-910-19-00-600-CF	1-910-39-00-601-CF	
		6	M14x1,5	17	24	49	46	17	24	1-910-01-00-600-CF	1-910-21-00-601-CF
		8	M16x1,5	19	24	49	47	19	24	1-910-03-00-600-CF	1-910-23-00-601-CF
	400	10	M18x1,5	22	24	49	48	22	24	1-910-05-00-600-CF	1-910-25-00-601-CF
		12	M20x1,5	24	24	49	47	24	24	1-910-07-00-600-CF	1-910-27-00-601-CF
		14	M22x1,5	27	27	51	50	27	27	1-910-08-00-600-CF	1-910-28-00-601-CF
	315	16	M24x1,5	30	30	52	55	30	30	1-910-10-00-600-CF	1-910-30-00-601-CF
		20	M30x2	36	32	53	62	36	36	1-910-12-00-600-CF	1-910-32-00-601-CF
		25	M36x2	46	41	58	62	46	41	1-910-14-00-600-CF	1-910-34-00-601-CF
	30	M42x2	50	46	60		upon request	1-910-16-00-600-CF	1-910-36-00-601-CF		
	38	M52x2	60	55	65		upon request	1-910-18-00-600-CF	1-910-38-00-601-CF		

For metal cap type A (universal) with vibration security

replace 600 by 590

replace 601 by 591

For metal cap type B (round) **without vibration security**

replace 600 by 020

replace 601 by 021

For metal cap type A (universal) **without vibration security**

replace 600 by 010

replace 601 by 011

For yellow plastic cap type A (universal) **without vibration security**

replace 600 by 100

replace 601 by 101

Design with sealings made of FKM

replace 00-600 by 02-600

replace 00-601 by 02-601

test coupling with 60° sealing cone (DKR) series M16x2 – valve function by ball

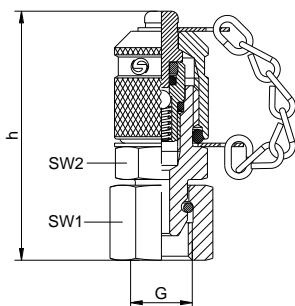

G	h	SW1	SW2	part number (NBR)	part number (FKM)
G 1/4	54	19	17	1-908-76-00-600-CF	1-908-76-02-600-CF

For metal cap type A (universal) with vibration security replace 600 by

590

590

For metal cap type B (round) **without vibration security** replace 600 by

020

020

For metal cap type A (universal) **without vibration security** replace 600 by

010

010

For yellow plastic cap type A (universal) **without vibration security** replace 600 by

100

100

Other dimensions on request. We reserve the right to change the technical performance. All dimensions in mm.

bulkhead coupling series M16x2 – valve function by ball

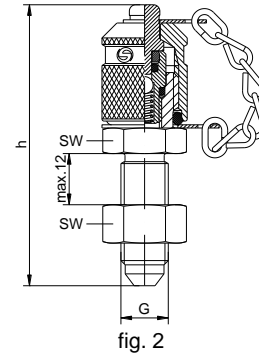
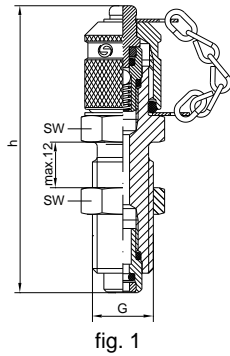

G	SW	h	fig.	part number (NBR)	part number (FKM)
M16x2	19	72	1	1-980-48-60-040-CF	1-980-48-60-041-CF
7/16-20 UNF	17	67	2	1-980-39-60-090-CF	1-980-39-60-091-CF
For metal cap type A (universal) with vibration security replace 60 by				59	59
For metal cap type B (round) without vibration security replace 60 by				02	02
For metal cap type A (universal) without vibration security replace 60 by				01	01
For yellow plastic cap type A (universal) without vibration security replace 60 by				10	10

bulkhead coupling series M16x2 – valve function by ball

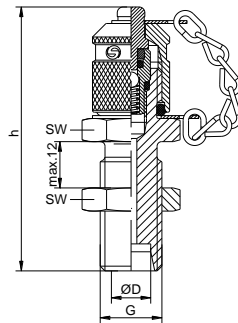

type	PN	tube ØD	G	SW1	SW2	h	part number (NBR)	part number (FKM)
L	315	6	M12x1,5	17	17	69	1-922-00-00-601-CF	1-922-00-02-601-CF
		8	M14x1,5	19	19	72	1-922-02-00-601-CF	1-922-02-02-601-CF
		10	M16x1,5	22	22	68	1-922-04-00-601-CF	1-922-04-02-601-CF
		12	M18x1,5	22	24	72	1-922-06-00-601-CF	1-922-06-02-601-CF
S	630	6	M14x1,5	19	19	71	1-922-01-00-601-CF	1-922-01-02-601-CF
		8	M16x1,5	22	22	72	1-922-03-00-601-CF	1-922-03-02-601-CF
		10	M18x1,5	24	24	72	1-922-05-00-601-CF	1-922-05-02-601-CF
		12	M20x1,5	upon request			1-922-07-00-601-CF	1-922-07-02-601-CF
For metal cap type A (universal) with vibration security replace 601 by							591	591
For metal cap type B (round) without vibration security replace 601 by							021	021
For metal cap type A (universal) without vibration security replace 601 by							011	011
For yellow plastic cap type A (universal) without vibration security replace 601 by							101	101

test coupling with 37° JIC female thread (DKJ) series M16x2 – valve function by ball

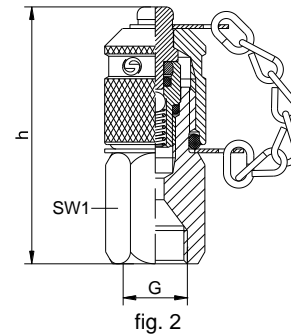
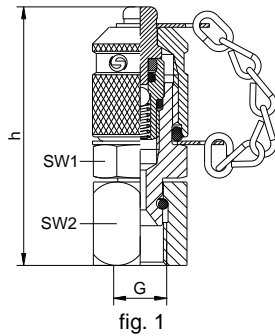

G	h	SW1	SW2	fig.	part number (NBR)	part number (FKM)
7/16 UNF	54	17	17	1	1-920-39-20-600-CF	1-920-39-22-600-CF
1/2 UNF	51	17	-	2	1-920-61-00-600-CF	1-920-61-02-600-CF
9/16 UNF	57	17	19	1	1-920-40-20-600-CF	1-920-40-22-600-CF
3/4 UNF	56	22	-	2	1-920-41-00-600-CF	1-920-41-02-600-CF
7/8 UNF	61	27	-	2	1-920-42-00-600-CF	1-920-42-02-600-CF
For metal cap type A (universal) with vibration security replace 600 by					590	590
For metal cap type B (round) without vibration security replace 600 by					020	020
For metal cap type A (universal) without vibration security replace 600 by					010	010
For yellow plastic cap type A (universal) without vibration security replace 600 by					100	100

90° swivel adaptor series M16x2 – valve function by ball

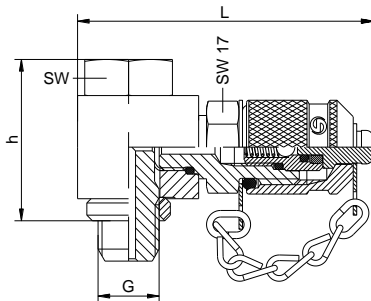

G	h	L	SW	part number (NBR)	part number (FKM)
G1/4	34	64	19	1-926-29-05-600-CF	upon request

For metal cap type A (universal) with vibration security replace 600 by				590	590
For metal cap type B (round) without vibration security replace 600 by				020	020
For metal cap type A (universal) without vibration security replace 600 by				010	010
For yellow plastic cap type A (universal) without vibration security replace 600 by				100	100

Application:

Spradow test couplings are applied for monitoring and control pressure as well as the ventilation. The advantages of this system are - among other - connection at system pressure level, the easy connection to measurement control and switching devices, the leakproof connection and the integrated vibration security of the metal cap.

Media:

Hydraulic oils and mineral based fluids.
(Please check compatibility of seal material.)

Materials:

Metal parts: Steel, Stainless steel upon request

Seals: NBR (-20 °C to +100 °C)
FKM (-20 °C to +200 °C)
EPDM (-40°C to +150 °C)

Hose: Polyamide (-35 °C to +100 °C)

Surface:

Zinc nickel, transparent, CrVI-free.

Pressure:

Maximum working pressure (PN) of the test couplings - 630 bar, at 4-fold security. Connection under pressure up to 400 bar. For the union pieces please observe the instructions given by the corresponding producer.

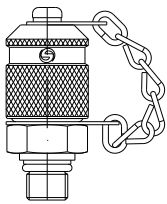
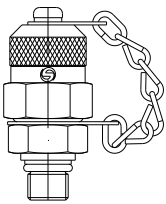
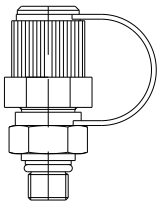

design types of caps

type B (round)	type A (universal)	type A (universal) plastic
		
standard: incl. vibration security		(temperature range -20°C to +100°C)

port connection and seals

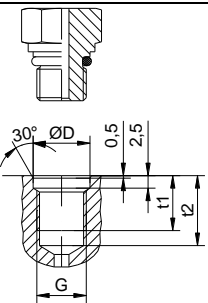
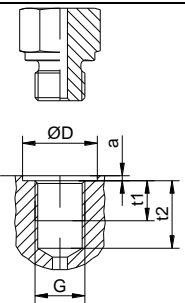
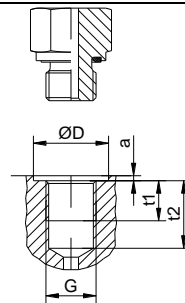
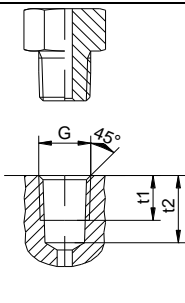
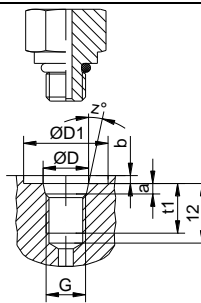
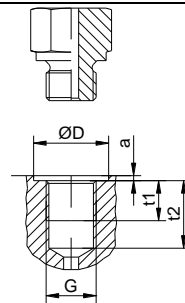
type 1	type 2	type 3	type 4	type 5	type 6
					
Design types of port connection and seals please see annex.					

Other dimensions on request. We reserve the right to change the technical performance. All dimensions in mm.

test coupling series M16x2 – valve function by piston

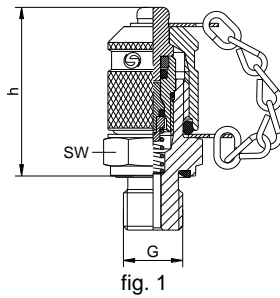

fig. 1

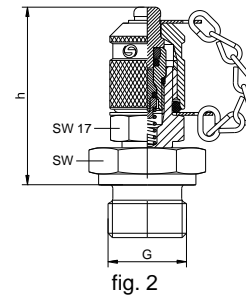

fig. 2

G	PN	SW	h	fig.	sealing	part number (NBR)	part number (FKM)
M8x1	250	17	38	1	o-ring type 1	1-Z06-20-21-600-CF	1-Z06-20-22-600-CF
M8x1		17	38	1	metal sealing type 2	1-Z06-20-30-600-CF	1-Z06-20-32-600-CF
M10x1	630	17	38	1	o-ring type 1	1-Z06-22-21-600-CF	1-Z06-22-22-600-CF
M10x1	400	17	38	1	metal sealing type 2	1-Z06-22-30-600-CF	1-Z06-22-32-600-CF
M10x1	400	17	39	1	soft sealing type 3	1-Z06-22-11-600-CF	1-Z06-22-12-600-CF
M10x1		17	38	1	metal sealing type 6	1-Z06-22-40-600-CF	1-Z06-22-42-600-CF
M10x1,25		17	38	1	o-ring type 1	1-Z06-49-21-600-CF	1-Z06-49-22-600-CF
M10x1,25		17	38	1	soft sealing type 3	1-Z06-49-11-600-CF	1-Z06-49-12-600-CF
M12x1,5	630	17	38	1	metal sealing type 2	1-Z06-23-30-600-CF	1-Z06-23-32-600-CF
M12x1,5	630	17	39	1	soft sealing type 3	1-Z06-23-11-600-CF	1-Z06-23-12-600-CF
M14x1,5	630	19	37	1	metal sealing type 2	1-Z06-24-30-600-CF	1-Z06-24-32-600-CF
M14x1,5	630	19	37	1	soft sealing type 3	1-Z06-24-11-600-CF	1-Z06-24-12-600-CF
M14x1,5	630	19	38	1	o-ring type 5	1-Z06-24-61-600-CF	1-Z06-24-62-600-CF
M16x1,5	630	22	37	1	metal sealing type 2	1-Z06-25-30-600-CF	1-Z06-25-32-600-CF
M16x1,5	630	22	37	1	soft sealing type 3	1-Z06-25-11-600-CF	1-Z06-25-12-600-CF
M18x1,5		24	39	1	metal sealing type 2	1-Z06-26-30-600-CF	1-Z06-26-32-600-CF
M18x1,5		24	39	1	soft sealing type 3	1-Z06-26-11-600-CF	1-Z06-26-12-600-CF
M20x1,5		27	39	1	metal sealing type 2	1-Z06-51-30-600-CF	1-Z06-51-32-600-CF
M20x1,5		27	39	1	soft sealing type 3	1-Z06-51-11-600-CF	1-Z06-51-12-600-CF
M22x1,5		27	39	1	metal sealing type 2	1-Z06-27-30-600-CF	1-Z06-27-32-600-CF
M22x1,5		27	39	1	soft sealing type 3	1-Z06-27-11-600-CF	1-Z06-27-12-600-CF
M26x1,5		32	49	2	metal sealing type 2	1-Z11-52-30-600-CF	1-Z11-52-32-600-CF
M27x2		36	49	2	metal sealing type 2	1-Z11-53-30-600-CF	1-Z11-53-32-600-CF
M33x2		41	49	2	metal sealing type 2	1-Z11-54-30-600-CF	1-Z11-54-32-600-CF
M42x2		50	50	2	metal sealing type 2	1-Z11-55-30-600-CF	1-Z11-55-32-600-CF
M48x2		60	50	2	metal sealing type 2	1-Z11-56-30-600-CF	1-Z11-56-32-600-CF
G 1/8	400	17	38	1	metal sealing type 2	1-Z06-28-30-600-CF	1-Z06-28-32-600-CF
G 1/8	400	17	39	1	soft sealing type 3	1-Z06-28-11-600-CF	1-Z06-28-12-600-CF
G 1/4	630	19	37	1	metal sealing type 2	1-Z06-29-30-600-CF	1-Z06-29-32-600-CF
G 1/4	630	19	37	1	soft sealing type 3	1-Z06-29-11-600-CF	1-Z06-29-12-600-CF
G 1/4		19	37	1	metal sealing type 6	1-Z06-29-40-600-CF	1-Z06-29-42-600-CF
G 3/8	630	22	37	1	metal sealing type 2	1-Z06-30-30-600-CF	1-Z06-30-32-600-CF
G 3/8	630	22	37	1	soft sealing type 3	1-Z06-30-11-600-CF	1-Z06-30-12-600-CF
G 1/2		27	39	1	metal sealing type 2	1-Z06-31-30-600-CF	1-Z06-31-32-600-CF
G 1/2	630	27	39	1	soft sealing type 3	1-Z06-31-11-600-CF	1-Z06-31-12-600-CF
G 3/4		32	40	1	metal sealing type 2	1-Z06-32-30-600-CF	1-Z06-32-32-600-CF
G 1		41	48	2	metal sealing type 2	1-Z11-57-30-600-CF	1-Z11-57-32-600-CF
G 1 1/4		50	50	2	metal sealing type 2	1-Z11-58-30-600-CF	1-Z11-58-32-600-CF
G 1 1/2		60	50	2	metal sealing type 2	1-Z11-59-30-600-CF	1-Z11-59-32-600-CF
Rk 1/8*	400	17	36	1	thread type 4	1-Z06-33-00-600-CF	1-Z06-33-02-600-CF
Rk 1/4*	630	17	35	1	thread type 4	1-Z06-34-00-600-CF	1-Z06-34-02-600-CF
Rk 3/8*		19	35	1	thread type 4	1-Z06-35-00-600-CF	1-Z06-35-02-600-CF
5/16-24 UNF	400	17	38	1	o-ring type 5	1-Z06-38-30-600-CF	1-Z06-38-32-600-CF
7/16-20 UNF	630	17	38	1	o-ring type 5	1-Z06-39-30-600-CF	1-Z06-39-32-600-CF
1/2-20 UNF	630	17	38	1	o-ring type 5	1-Z06-61-30-600-CF	1-Z06-61-32-600-CF
9/16-18 UNF	630	19	38	1	o-ring type 5	1-Z06-40-30-600-CF	1-Z06-40-32-600-CF
3/4-16 UNF	630	27	40	1	o-ring type 5	1-Z06-41-30-600-CF	1-Z06-41-32-600-CF
1/8 NPT	400	17	36	1	thread type 4	1-Z06-43-00-600-CF	1-Z06-43-02-600-CF
1/4 NPT	630	17	35	1	thread type 4	1-Z06-44-00-600-CF	1-Z06-44-02-600-CF
3/8 NPT		19	36	1	thread type 4	1-Z06-45-00-600-CF	1-Z06-45-02-600-CF
1/2 NPT		22	37	1	thread type 4	1-Z06-46-00-600-CF	1-Z06-46-02-600-CF
For metal cap type A (universal) with vibration security replace 600 by						590	590
For metal cap type B (round) without vibration security replace 600 by						020	020
For metal cap type A (universal) without vibration security replace 600 by						010	010
For yellow plastic cap type A (universal) without vibration security replace 600 by						100	100

*acc. DIN 3858

Other dimensions on request. We reserve the right to change the technical performance. All dimensions in mm.

fitting with test coupling series M16x2 – valve function by piston

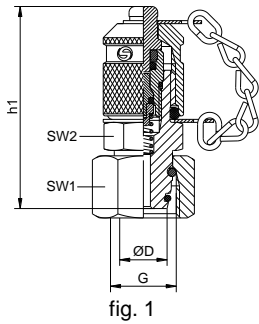

fig. 1

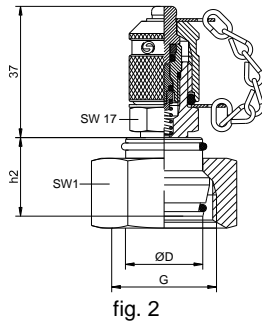

fig. 2

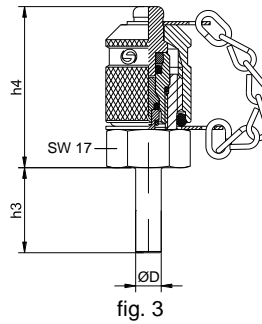

fig. 3

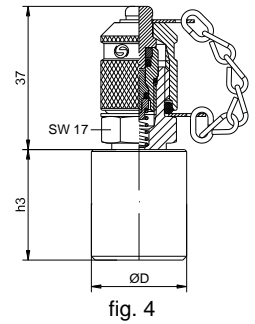

fig. 4

type DKO

test coupling with 24° taper adapter

type BE

test coupling for compression ring fittings

type	PN	tube ØD	h1	h2	h3	h4	SW1	SW2	G	type DKO part number	fig.	type BE part number	fig.
L	315	6	53	-	20	39	14	17	M12x1,5	1-Z08-00-10-600-CF	1	1-Z09-00-00-601-CF	3
		8	53	-	20	39	17	17	M14x1,5	1-Z08-02-10-600-CF	1	1-Z09-02-00-601-CF	3
		10	50	-	22	37	19	17	M16x1,5	1-Z08-04-10-600-CF	1	1-Z09-04-00-601-CF	3
		12	50	-	22	37	22	17	M18x1,5	1-Z08-06-10-600-CF	1	1-Z09-06-00-601-CF	3
		15	51	-	22	37	27	19	M22x1,5	1-Z08-09-00-600-CF	1	1-Z09-09-00-601-CF	3
		18	-	22	28	-	32	-	M26x1,5	1-Z08-11-00-600-CF	2	1-Z09-11-00-601-CF	4
	160	22	-	22	30	-	36	-	M30x2	1-Z08-13-00-600-CF	2	1-Z09-13-00-601-CF	4
		28	-	24	32	-	41	-	M36x2	1-Z08-15-00-600-CF	2	1-Z09-15-00-601-CF	4
		35	-	27	42	-	50	-	M45x2	1-Z08-17-00-600-CF	2	1-Z09-17-00-601-CF	4
		42	-	28	45	-	60	-	M52x2	1-Z08-19-00-600-CF	2	1-Z09-19-00-601-CF	4
S	630	6	54	-	20	39	17	17	M14x1,5	1-Z08-01-10-600-CF	1	1-Z09-00-00-601-CF	3
		8	51	-	20	39	19	17	M16x1,5	1-Z08-03-10-600-CF	1	1-Z09-02-00-601-CF	3
		10	51	-	22	37	22	17	M18x1,5	1-Z08-05-10-600-CF	1	1-Z09-04-00-601-CF	3
		12	51	-	22	37	24	17	M20x1,5	1-Z08-07-10-600-CF	1	1-Z09-06-00-601-CF	3
		14	-	24	22	37	27	-	M22x1,5	1-Z08-08-00-600-CF	1	1-Z09-08-00-601-CF	3
		16	-	20	28	37	30	-	M24x1,5	1-Z08-10-00-600-CF	2	1-Z09-10-00-601-CF	3
	400	20	-	25	30	-	36	-	M30x2	1-Z08-12-00-600-CF	2	1-Z09-12-00-601-CF	4
		25	-	27	36	-	46	-	M36x2	1-Z08-14-00-600-CF	2	1-Z09-14-00-601-CF	4
		30	-	29	41	-	50	-	M42x2	1-Z08-16-00-600-CF	2	1-Z09-16-00-601-CF	4
		315	38	-	32	48	-	60	-	M52x2	1-Z08-18-00-600-CF	2	1-Z09-18-00-601-CF

For metal cap type A (universal) with vibration security
 For metal cap type B (round) **without vibration security**
 For metal cap type A (universal) **without vibration security**
 For yellow plastic cap type A (universal) **without vibration security**
 Design with sealings made of FKM

replace 600 by 590
 replace 600 by 020
 replace 600 by 010
 replace 600 by 100
 replace 10 by 12
 or replace 00 by 02

replace 601 by 591
 replace 601 by 021
 replace 601 by 011
 replace 601 by 101
 replace 00-601 by 02-601

90° fitting type BE with test coupling series M16x2 – valve function by piston

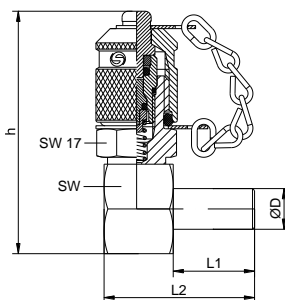

tube ØD	L1	L2	SW	h	part number (NBR)	part number (FKM)
8	20	37	22	59	1-Z80-03-60-080-CF	1-Z80-03-60-081-CF
10	20	37	22	59	1-Z80-05-60-120-CF	1-Z80-05-60-121-CF

For metal cap type A (universal) with vibration security replace 60 by 59
 For metal cap type B (round) **without vibration security** replace 60 by 02
 For metal cap type A (universal) **without vibration security** replace 60 by 01
 For yellow plastic cap type A (universal) **without vibration security** replace 60 by 10

59
 02
 01
 10

Other dimensions on request. We reserve the right to change the technical performance. All dimensions in mm.

fitting with test coupling series M16x2 – valve function by piston

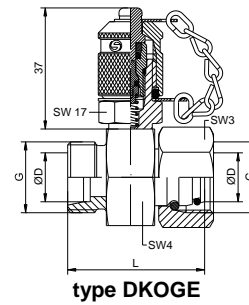
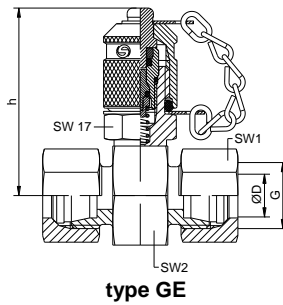

type	PN	tube ØD	G	SW1	SW2	h	L	SW3	SW4	type GE part number	type DKOGE part number
L	315	6	M12x1,5	14	22	48	43	14	24	1-Z10-00-00-600-CF	1-Z10-20-00-601-CF
		8	M14x1,5	17	24	49	43	17	24	1-Z10-02-00-600-CF	1-Z10-22-00-601-CF
		10	M16x1,5	19	24	49	45	19	24	1-Z10-04-00-600-CF	1-Z10-24-00-601-CF
		12	M18x1,5	22	27	51	41	22	27	1-Z10-06-00-600-CF	1-Z10-26-00-601-CF
		15	M22x1,5	27	30	53	43	27	30	1-Z10-09-00-600-CF	1-Z10-29-00-601-CF
		18	M26x1,5	32	32	53	54	32	32	1-Z10-11-00-600-CF	1-Z10-31-00-601-CF
	160	22	M30x2	36	36	55	57	36	36	1-Z10-13-00-600-CF	1-Z10-33-00-601-CF
		28	M36x2	41	41	58		upon request		1-Z10-15-00-600-CF	1-Z10-35-00-601-CF
		35	M45x2	50	46	60		upon request		1-Z10-17-00-600-CF	1-Z10-37-00-601-CF
		42	M52x2	60	55	65		upon request		1-Z10-19-00-600-CF	1-Z10-39-00-601-CF
S	630	6	M14x1,5	17	24	49	46	17	24	1-Z10-01-00-600-CF	1-Z10-21-00-601-CF
		8	M16x1,5	19	24	49	47	19	24	1-Z10-03-00-600-CF	1-Z10-23-00-601-CF
		10	M18x1,5	22	24	49	48	22	24	1-Z10-05-00-600-CF	1-Z10-25-00-601-CF
		12	M20x1,5	24	24	49	47	24	24	1-Z10-07-00-600-CF	1-Z10-27-00-601-CF
		14	M22x1,5	27	27	51	50	27	27	1-Z10-08-00-600-CF	1-Z10-28-00-601-CF
		16	M24x1,5	30	30	52	55	30	30	1-Z10-10-00-600-CF	1-Z10-30-00-601-CF
	400	20	M30x2	36	32	53	62	36	36	1-Z10-12-00-600-CF	1-Z10-32-00-601-CF
		25	M36x2	46	41	58	62	46	41	1-Z10-14-00-600-CF	1-Z10-34-00-601-CF
		30	M42x2	50	46	60		upon request		1-Z10-16-00-600-CF	1-Z10-36-00-601-CF
		315	38	M52x2	60	55	65		upon request		1-Z10-18-00-600-CF

For metal cap type A (universal) with vibration security	replace 600 by 590	replace 601 by 591
For metal cap type B (round) without vibration security	replace 600 by 020	replace 601 by 021
For metal cap type A (universal) without vibration security	replace 600 by 010	replace 601 by 011
For yellow plastic cap type A (universal) without vibration security	replace 600 by 100	replace 601 by 101
Design with sealings made of FKM	replace 00-600 by 02-600	replace 00-601 by 02-601

test coupling with 60° sealing cone (DKR) series M16x2 – valve function by piston

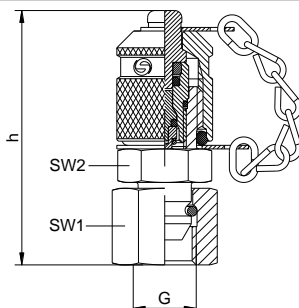

G	h	SW1	SW2	part number (NBR)	part number (FKM)
G 1/4	54	19	17	1-Z08-76-00-600-CF	1-Z08-76-02-600-CF

For metal cap type A (universal) with vibration security	replace 600 by 590	590
For metal cap type B (round) without vibration security	replace 600 by 020	020
For metal cap type A (universal) without vibration security	replace 600 by 010	010
For yellow plastic cap type A (universal) without vibration security	replace 600 by 100	100

Other dimensions on request. We reserve the right to change the technical performance. All dimensions in mm.

bulkhead coupling series M16x2 – valve function by piston

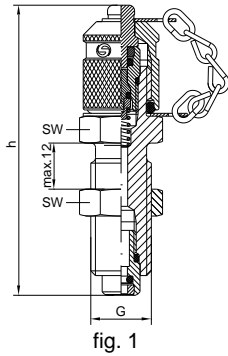

fig. 1

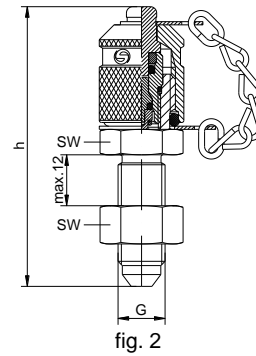
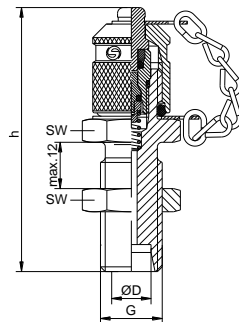

fig. 2

G	SW	h	fig.	part number (NBR)	part number (FKM)
M16x2	19	72	1	1-Z80-48-60-040-CF	1-Z80-48-60-041-CF
7/16-20 UNF	17	68	2	upon request	upon request
For metal cap type A (universal) with vibration security replace 60 by				59	59
For metal cap type B (round) without vibration security replace 60 by				02	02
For metal cap type A (universal) without vibration security replace 60 by				01	01
For yellow plastic cap type A (universal) without vibration security replace 60 by				10	10

bulkhead coupling series M16x2 – valve function by piston



type	PN	tube ØD	G	SW1	SW2	h	part number (NBR)	part number (FKM)
L	315	6	M12x1,5	17	17	69	1-Z22-00-00-601-CF	1-Z22-00-02-601-CF
		8	M14x1,5	19	19	72	1-Z22-02-00-601-CF	1-Z22-02-02-601-CF
		10	M16x1,5	22	22	68	1-Z22-04-00-601-CF	1-Z22-04-02-601-CF
		12	M18x1,5	22	24	72	1-Z22-06-00-601-CF	1-Z22-06-02-601-CF
S	630	6	M14x1,5	19	19	71	1-Z22-01-00-601-CF	1-Z22-01-02-601-CF
		8	M16x1,5	22	22	72	1-Z22-03-00-601-CF	1-Z22-03-02-601-CF
		10	M18x1,5	24	24	72	1-Z22-05-00-601-CF	1-Z22-05-02-601-CF
		12	M20x1,5	upon request			1-Z22-07-00-601-CF	1-Z22-07-02-601-CF
For metal cap type A (universal) with vibration security replace 601 by							591	591
For metal cap type B (round) without vibration security replace 601 by							021	021
For metal cap type A (universal) without vibration security replace 601 by							011	011
For yellow plastic cap type A (universal) without vibration security replace 601 by							101	101

test coupling with 37° JIC female thread (DKJ) series M16x2 – valve function by piston

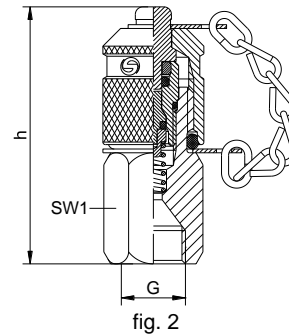
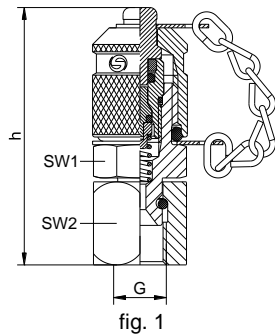

G	h	SW1	SW2	fig.	part number (NBR)	part number (FKM)
7/16 UNF	54	17	17	1	1-Z20-39-20-600-CF	1-Z20-39-22-600-CF
1/2 UNF	51	17	-	2	1-Z20-61-00-600-CF	1-Z20-61-02-600-CF
9/16 UNF	57	17	19	1	1-Z20-40-20-600-CF	1-Z20-40-22-600-CF
3/4 UNF	56	22	-	2	1-Z20-41-00-600-CF	1-Z20-41-02-600-CF
7/8 UNF	61	27	-	2	1-Z20-42-00-600-CF	1-Z20-42-02-600-CF
For metal cap type A (universal) with vibration security replace 600 by					590	590
For metal cap type B (round) without vibration security replace 600 by					020	020
For metal cap type A (universal) without vibration security replace 600 by					010	010
For yellow plastic cap type A (universal) without vibration security replace 600 by					100	100

90° swivel adaptor series M16x2 – valve function by piston

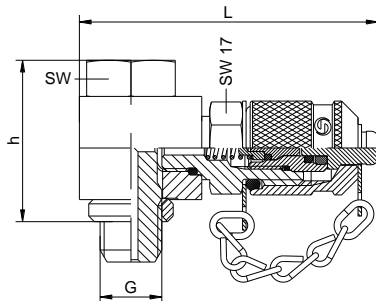

G	h	L	SW	part number (NBR)	part number (FKM)
G1/4	34	64	17	1-Z26-29-05-600-CF	upon request

For metal cap type A (universal) with vibration security replace 600 by					590	590
For metal cap type B (round) without vibration security replace 600 by					020	020
For metal cap type A (universal) without vibration security replace 600 by					010	010
For yellow plastic cap type A (universal) without vibration security replace 600 by					100	100

***Media:**

These spradow test couplings are designed for nitrogen and other inert gases.

Application:

Spradow nitrogen test couplings are applied for the monitoring and control pressure as well as the ventilation. The advantages of this system are – among other – connection at system pressure level, the easy connection to measurement control and switching devices, the leakproof connection and the integrated vibration security of the metal cap.

Materials:

Metal parts: Steel, Stainless steel upon request
Seals: material 1 (-20 °C to +100 °C) - standard
material 2 (-47 °C to +100 °C)
Hose: Polyamide (-35 °C to +100 °C)

Surface:

CrVI-free.

Pressure:

Maximum working pressure (PN) of the test couplings - 630 bar at 4-fold security. Connection under pressure up to 400 bar. For the union pieces please observe the instructions given by the corresponding producer.

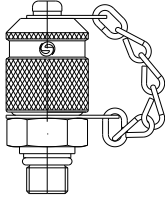
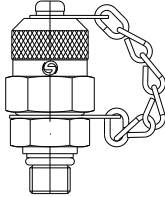
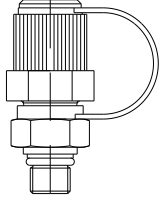

design types of caps

type B (round)	type A (universal)	type A (universal) plastic
		
standard: incl. vibration security		(temperature range -20°C to +100°C)

port connection and seals

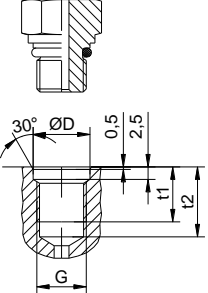
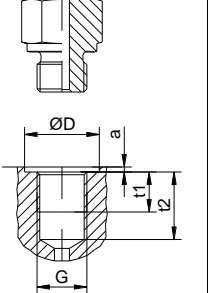
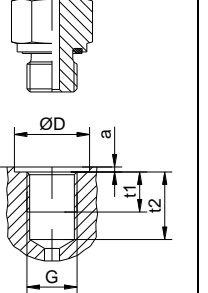
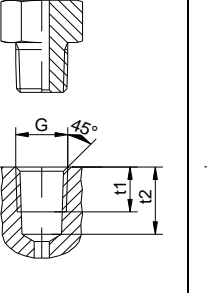
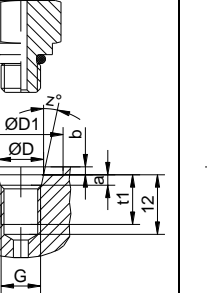
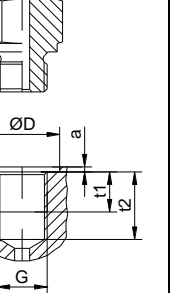
type 1	type 2	type 3	type 4	type 5	type 6
					
Design types of port connection and seals please see annex.					

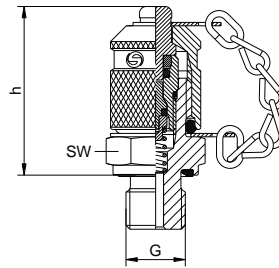

fig. 1

G	PN	SW	h	fig.	sealing	part number (NBR)
M8x1	250	17	38	1	o-ring type 1	1-G06-20-21-600-CF
M10x1	630	17	38	1	o-ring type 1	1-G06-22-21-600-CF
M10x1	400	17	39	1	soft sealing type 3	1-G06-22-11-600-CF
M10x1,25		17	38	1	o-ring type 1	1-G06-49-21-600-CF
M10x1,25		17	38	1	soft sealing type 3	1-G06-49-11-600-CF
M12x1,5	630	17	39	1	soft sealing type 3	1-G06-23-11-600-CF
M14x1,5	630	19	37	1	soft sealing type 3	1-G06-24-11-600-CF
M14x1,5	630	19	38	1	o-ring type 5	1-G06-24-61-600-CF
M16x1,5	630	22	37	1	soft sealing type 3	1-G06-25-11-600-CF
M18x1,5		24	39	1	soft sealing type 3	1-G06-26-11-600-CF
M20x1,5		27	39	1	soft sealing type 3	1-G06-51-11-600-CF
M22x1,5		27	39	1	soft sealing type 3	1-G06-27-11-600-CF
G 1/8	400	17	39	1	soft sealing type 3	1-G06-28-11-600-CF
G 1/4	630	19	37	1	soft sealing type 3	1-G06-29-11-600-CF
G 3/8	630	22	37	1	soft sealing type 3	1-G06-30-11-600-CF
G 1/2	630	27	39	1	soft sealing type 3	1-G06-31-11-600-CF
5/16-24 UNF	400	17	38	1	o-ring type 5	1-G06-38-30-600-CF
7/16-20 UNF	630	17	38	1	o-ring type 5	1-G06-39-30-600-CF
1/2-20 UNF	630	17	38	1	o-ring type 5	1-G06-61-30-600-CF
9/16-18 UNF	630	19	38	1	o-ring type 5	1-G06-40-30-600-CF
3/4-16 UNF	630	27	40	1	o-ring type 5	1-G06-41-30-600-CF

For metal cap type A (universal) with vibration security replace 600 by

590

For metal cap type B (round) **without vibration security** replace 600 by

020

For metal cap type A (universal) **without vibration security** replace 600 by

010

For yellow plastic cap type A (universal) **without vibration security** replace 600 by

100

test coupling
series M16x2 – GAS for arctic temperature

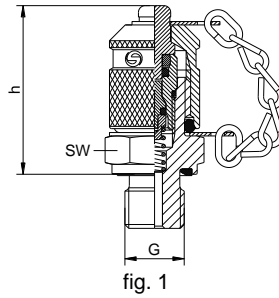

G	PN	SW	h	fig.	sealing	part number
for arctic temperature use (sealings material 2; metal parts stainless steel 1.4305)						
M8x1	250	17	38	1	o-ring type 1	upon request
M10x1	630	17	38	1	o-ring type 1	upon request
M10x1	400	17	39	1	soft sealing type 3	upon request
M10x1,25		17	38	1	o-ring type 1	upon request
M10x1,25		17	38	1	soft sealing type 3	upon request
M12x1,5	630	17	39	1	soft sealing type 3	upon request
M14x1,5	630	19	37	1	soft sealing type 3	upon request
M14x1,5	630	19	38	1	o-ring type 5	upon request
M16x1,5	630	22	37	1	soft sealing type 3	1-T12-29-23-660-05 ¹
M18x1,5		24	39	1	soft sealing type 3	upon request
M20x1,5		27	39	1	soft sealing type 3	upon request
M22x1,5		27	39	1	soft sealing type 3	upon request
G 1/8	400	17	39	1	soft sealing type 3	upon request
G 1/4	630	19	37	1	soft sealing type 3	upon request
G 3/8	630	22	37	1	soft sealing type 3	upon request
G 1/2	630	27	39	1	soft sealing type 3	upon request
5/16-24 UNF	400	17	38	1	o-ring type 5	upon request
7/16-20 UNF	630	17	38	1	o-ring type 5	upon request
1/2-20 UNF	630	17	38	1	o-ring type 5	upon request
9/16-18 UNF	630	19	38	1	o-ring type 5	upon request
3/4-16 UNF	630	27	40	1	o-ring type 5	upon request

¹Sealing element is an o-ring

For metal cap type A (universal) with vibration security replace 600 by	650
For metal cap type B (round) without vibration security replace 600 by	080
For metal cap type A (universal) without vibration security replace 600 by	070
For yellow plastic cap type A (universal) without vibration security replace 600 by	100

fitting with test coupling series M16x2 - GAS

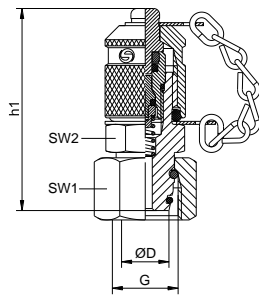

fig. 1

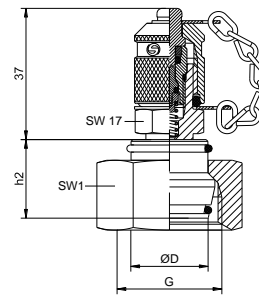

fig. 2

type DKO
test coupling with 24° taper adapter

type	PN	tube ØD	h1	h2	SW1	SW2	G	type DKO part number	fig.
L	315	6	53	-	14	17	M12x1,5	upon request	1
		8	53	-	17	17	M14x1,5	upon request	1
		10	50	-	19	17	M16x1,5	upon request	1
		12	50	-	22	17	M18x1,5	upon request	1
		15	51	-	27	19	M22x1,5	upon request	1
	160	18	-	22	32	-	M26x1,5	upon request	2
		22	-	22	36	-	M30x2	upon request	2
		28	-	24	41	-	M36x2	upon request	2
		35	-	27	50	-	M45x2	upon request	2
		42	-	28	60	-	M52x2	upon request	2
S	630	6	54	-	17	17	M14x1,5	upon request	1
		8	51	-	19	17	M16x1,5	upon request	1
		10	51	-	22	17	M18x1,5	upon request	1
		12	51	-	24	17	M20x1,5	upon request	1
		14	53	-	27	19	M22x1,5	upon request	1
	400	16	-	20	30	-	M24x1,5	upon request	2
		20	-	25	36	-	M30x2	upon request	2
		25	-	27	46	-	M36x2	upon request	2
		30	-	29	50	-	M42x2	upon request	2
		315	38	-	32	60	-	M52x2	upon request
For metal cap type A (universal) with vibration security								upon request	
For metal cap type B (round) without vibration security								upon request	
For metal cap type A (universal) without vibration security								upon request	
For yellow plastic cap type A (universal) without vibration security								upon request	

Other dimensions on request. We reserve the right to change the technical performance. All dimensions in mm.

bulkhead pressure gauge connector series M16x2 – GAS – without valve function

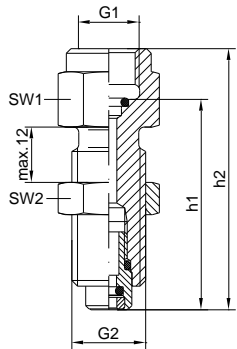

G1	SW1	SW2	h1	h2	G2	sealing	part number
G 1/4	19	19	46	57	M16x2	o-ring	1-918-29-01-240-CF
G 1/2	27	24	49	66	M16x2	o-ring	1-918-31-01-240-CF

direct pressure gauge connector Series M16x2 - GAS – without valve function

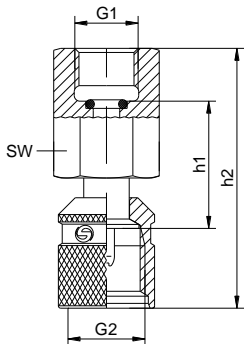

G1	SW	h1	h2	G2	sealing	part number
G 1/4	19	27	54	M16x2	o-ring	1-927-29-01-020-CF
G 1/2	27	25	58	M16x2	o-ring	1-927-31-01-020-CF

For metal cap type A (universal) replace 020 by

010

bulkhead coupling series M16x2 - GAS

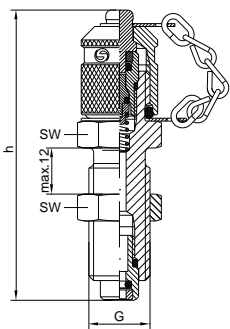

G	SW	h	part number
M16x2	19	72	upon request

For metal cap type A (universal) with vibration security	upon request
For metal cap type B (round) without vibration security	upon request
For metal cap type A (universal) without vibration security	upon request
For yellow plastic cap type A (universal) without vibration security	upon request

hose connector series M16x2 – GAS – without valve function

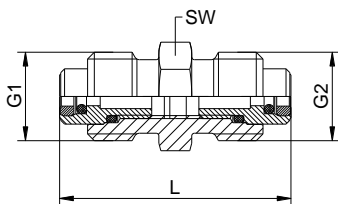

G1	SW	L	G2	arctic temperature	
				part number	part number
M16x2	17	42	M16x2	1-T80-48-00-020-CF	1-980-48-00-020-CF
M16x2	17	42	M16x1,5	1-T80-48-00-030	1-980-48-00-030

Other dimensions on request. We reserve the right to change the technical performance. All dimensions in mm.

M16x2 – connectors and adaptors

bulkhead pressure gauge connector series M16x2 – without valve function

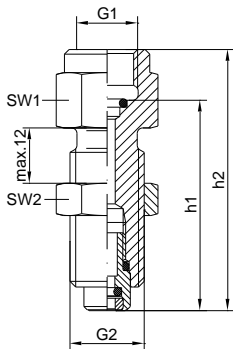

G1	SW1	SW2	h1	h2	G2	sealing	part number (NBR)	part number (FKM)
G 1/4	19	19	46	57	M16x2	o-ring	1-918-29-01-240-CF	1-918-29-21-240-CF
G 1/2	27	24	49	66	M16x2	o-ring	1-918-31-01-240-CF	1-918-31-21-240-CF
1/4 NPT	19	19	-	58	M16x2	thread	1-918-44-00-240-CF	1-918-44-20-240-CF
1/2 NPT	27	24	-	66	M16x2	thread	1-918-46-00-240-CF	1-918-46-20-240-CF

For design with damping element replace 918 by

930

930

pressure gauge connector 90° series M16x2 – without valve function

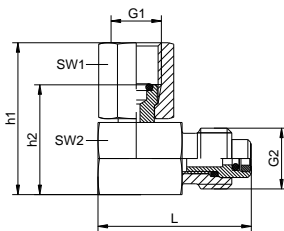

G1	SW1	SW2	L	h1	h2	G2	part number (NBR)	part number (FKM)
G 1/4	17	19	40	40	29	M16x2	1-928-29-01-240-CF	1-928-29-21-240-CF
G 1/2			upon request			M16x2	1-928-31-01-240-CF	1-928-31-21-240-CF

direct pressure gauge connector series M16x2 – without valve function

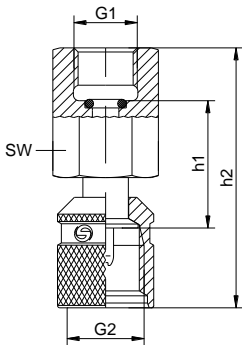

G1	SW	h1	h2	G2	sealing	part number (NBR)	part number (FKM)
G 1/4	19	27	54	M16x2	o-ring	1-927-29-01-020-CF	1-927-29-21-020-CF
G 1/2	27	25	58	M16x2	o-ring	1-927-31-01-020-CF	1-927-31-21-020-CF
1/4 NPT	19	-	53	M16x2	thread	1-927-44-00-020-CF	1-927-44-20-020-CF
1/2 NPT	27	-	59	M16x2	thread	1-927-46-00-020-CF	1-927-46-20-020-CF

For metal cap type A (universal) replace 020 by

010

010

For design with damping element replace 927 by

929

929

direct pressure gauge connector 90° series M16x2 – without valve function

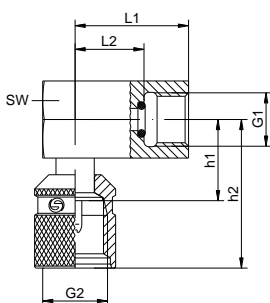

G1	SW	L1	L2	h1	h2	G2	part number (NBR)	part number (FKM)
G 1/4	19	28	17	20	37	M16x2	1-928-29-01-020-CF	1-928-29-21-020-CF
G 1/2	27	28	11	24	41	M16x2	1-928-31-01-020-CF	1-928-31-21-020-CF
1/4 NPT	19	22	-	20	37	M16x2	1-928-44-00-020-CF	1-928-44-20-020-CF
1/2 NPT	27	28	-	24	41	M16x2	1-928-46-00-020-CF	1-928-46-20-020-CF

For metal cap type A (universal) replace 020 by

010

010

Other dimensions on request. We reserve the right to change the technical performance. All dimensions in mm.

M16x2 – connectors and adaptors

bulkhead sensor connector series M16x2 – without valve function

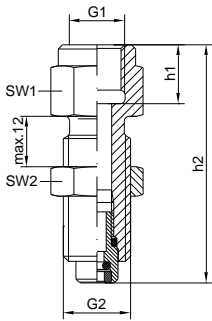

G1	SW1	SW2	h1	h2	G2	part number (NBR)	part number (FKM)
G 1/4	19	19	14	57	M16x2	1-718-29-00-240-CF	upon request

direct sensor connector series M16x2 – without valve function

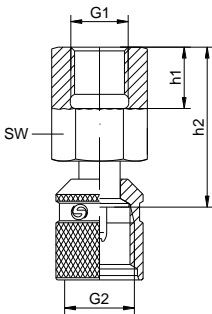

G1	SW	h1	h2	G2	part number (NBR)	part number (FKM)
G 1/4	19	14	37	M16x2	1-727-29-00-021-CF	upon request
G 1/2	27	15	38	M16x2	1-727-31-00-020-CF	upon request

For metal cap type A (universal) replace 020 by 010
respectively
replace 021 by 011

direct sensor connector 90° series M16x2 – without valve function

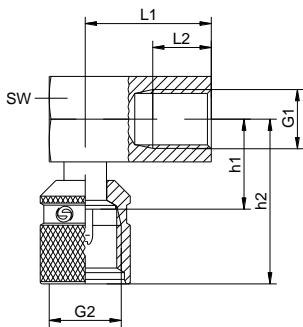

G1	SW	L1	L2	h1	h2	G2	part number (NBR)	part number (FKM)
G 1/4	19	28	13	20	37	M16x2	1-728-29-00-021-CF	upon request

For metal cap type A (universal) replace 021 by 011

M16x2 - connectors and adaptors

adaptor for test coupling series M16x2 – without valve function

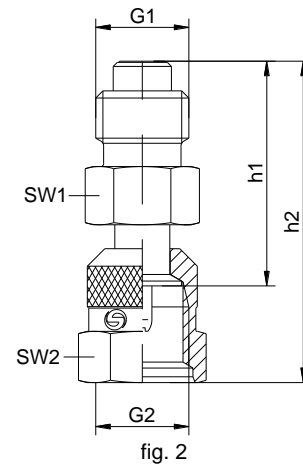
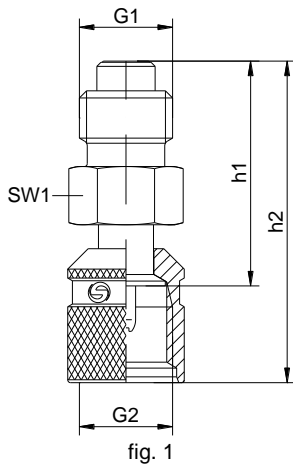

G1	G2	h1	h2	SW1	SW2	fig.	part number (NBR)	part number (FKM)
M16x2	M16x1,5	39	56	17	-	1	1-980-25-00-050	upon request
M16x2	S12x1,5	39	50	17	-	1	1-980-49-00-100-CF	upon request
M16x1,5	M16x2	39	56	17	19	2	1-980-48-00-120	upon request
S12x1,5	M16x2	36	47	17	19	2	1-980-48-00-110-CF	upon request

adaptor for series 5/8"-14 BSF (HSP) series M16x2 – valve function by ball

This adapter has been constructed to enable an adaptation between the 5/8"-14 BSF system (HSP) to the world wide used M16x2 system. Just screw our adapter onto the HSP - test coupling. The result is a regular M16x2 system connection. Now you can use your hoses and fittings from the M16x2 system.

with valve function (ball)

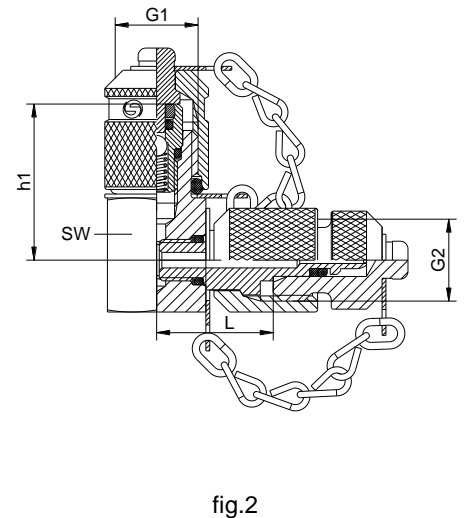
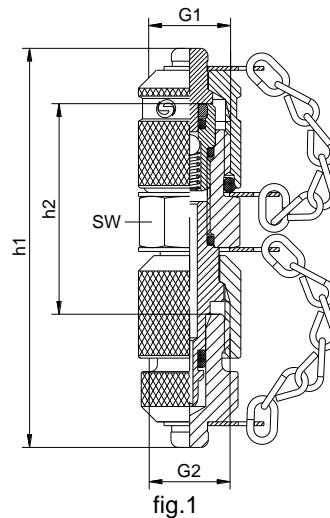

G1	G2	h1	h2	L	SW	fig.	part number (NBR)	part number (FKM)
M16x2	5/8"-14 BSF	78	41	-	17	1	1-880-67-60-001-CF	upon request
M16x2	5/8"-14 BSF	30	-	23	19	2	1-880-67-60-002-CF	upon request

For metal cap type A (universal) with vibration security replace 60 by	59	upon request
For metal cap type B (round) without vibration security replace 60 by	02	upon request
For metal cap type A (universal) without vibration security replace 60 by	01	upon request
For yellow plastic cap type A (universal) without vibration security replace 60 by	10	upon request

Other dimensions on request. We reserve the right to change the technical performance. All dimensions in mm.

M16x2 - connectors and adaptors

adaptor for test coupling 90° series M16x2 – without valve function

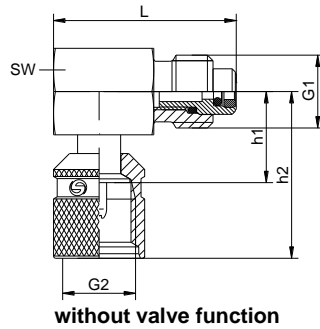

G1	G2	L	h1	h2	SW	part number (NBR)	part number (FKM)
M16x2	M16x2	40	20	37	19	1-924-02-00-241-CF	1-924-02-02-241-CF
metal cap type A (universal)						1-924-01-00-241-CF	1-924-01-02-241-CF

adaptor for test coupling 90° series M16x2 – valve function by ball

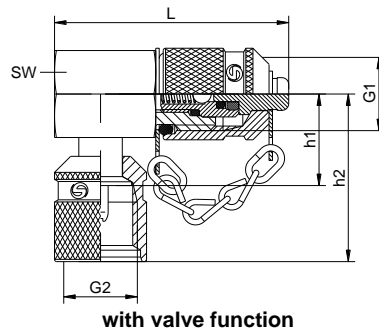

G1	G2	L	h1	h2	SW	part number (NBR)	part number (FKM)
M16x2	M16x2	51	20	37	19	1-924-02-00-600-CF	1-924-02-02-600-CF
metal cap type A (universal) with vibration security						1-924-01-00-590-CF	1-924-01-02-590-CF
metal cap type B (round) without vibration security						1-924-02-00-020-CF	1-924-02-02-020-CF
metal cap type A (universal) without vibration security						1-924-01-00-010-CF	1-924-01-02-010-CF
plastic cap type A (universal) yellow without vibration security						1-924-01-00-100-CF	1-924-01-02-100-CF

high pressure hose series M16x2

Max. working pressure:
up to 630 bar

Pressure / t° factor:
at 20°C 100%
at 40°C 95%
at 60°C 90%
at 80°C 80%
at 100°C 70%

Further details please
see section hoses and
connectors

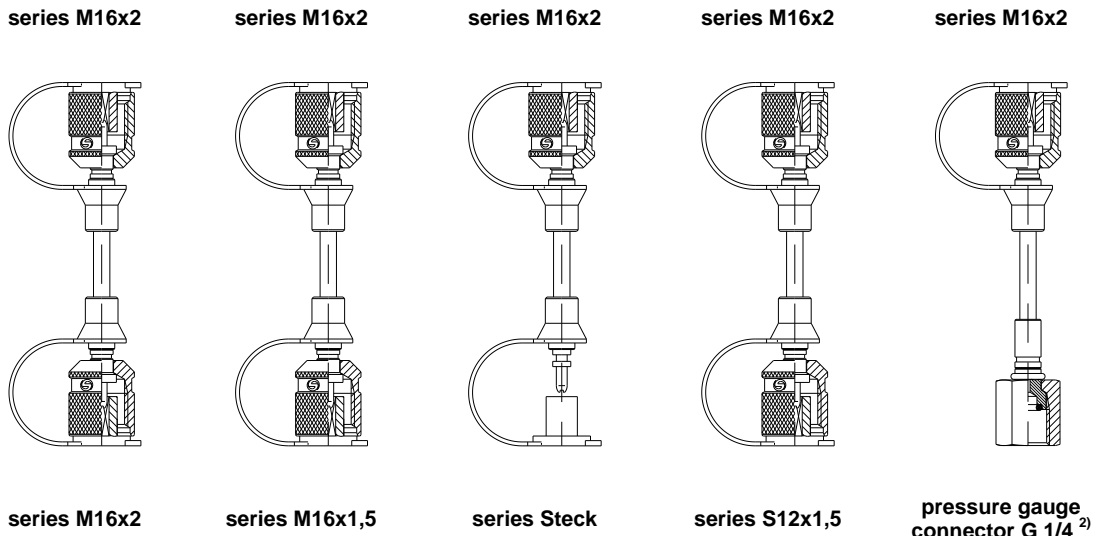

length L ¹⁾ acc. DIN 20066	series M16x2	series M16x1,5	series Steck	series S12x1,5	pressure gauge connector G 1/4 ²⁾
	part number				
200	1-971-04-04-010-CF	1-971-04-10-010-CF	1-971-01-04-010-CF	1-971-04-12-010-CF	1-971-02-04-010-CF
400	1-971-04-04-040-CF	1-971-04-10-040-CF	1-971-01-04-040-CF	1-971-04-12-040-CF	1-971-02-04-040-CF
630	1-971-04-04-060-CF	1-971-04-10-060-CF	1-971-01-04-060-CF	1-971-04-12-060-CF	1-971-02-04-060-CF
800	1-971-04-04-080-CF	1-971-04-10-080-CF	1-971-01-04-080-CF	1-971-04-12-080-CF	1-971-02-04-080-CF
1000	1-971-04-04-090-CF	1-971-04-10-090-CF	1-971-01-04-090-CF	1-971-04-12-090-CF	1-971-02-04-090-CF
1500	1-971-04-04-100-CF	1-971-04-10-100-CF	1-971-01-04-100-CF	1-971-04-12-100-CF	1-971-02-04-100-CF
2000	1-971-04-04-110-CF	1-971-04-10-110-CF	1-971-01-04-110-CF	1-971-04-12-110-CF	1-971-02-04-110-CF
2500	1-971-04-04-120-CF	1-971-04-10-120-CF	1-971-01-04-120-CF	1-971-04-12-120-CF	1-971-02-04-120-CF
3200	1-971-04-04-130-CF	1-971-04-10-130-CF	1-971-01-04-130-CF	1-971-04-12-130-CF	1-971-02-04-130-CF
4000	1-971-04-04-140-CF	1-971-04-10-140-CF	1-971-01-04-140-CF	1-971-04-12-140-CF	1-971-02-04-140-CF

¹⁾ Other lengths upon request

Further connectors please see chapter
hoses and connectors

²⁾ Connection thread G¹/₂,
¹/₄ NPT and ¹/₂ NPT upon request.

For pricked hose (use with gases) replace 971 by 975
For metal cap M16x2 type A (universal) replace 04 by 03
For metal cap M16x1,5 type A (universal) replace 10 by 09

The information on the definition of the hose assembly lengths, please see the annex.

hose connector series M16x2 – without valve function

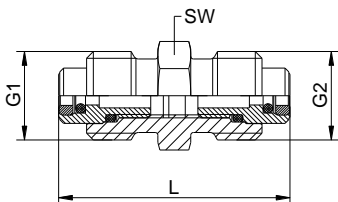

G1	SW	L	G2	part number (NBR)	part number (FKM)
M16x2	17	42	M16x2	1-980-48-00-020-CF	upon request
M16x2	17	42	M16x1,5	1-980-48-00-030-CF	upon request

Other dimensions on request. We reserve the right to change the technical performance. All dimensions in mm.

stainless steel M16x2 - piston

Application:

Spradow test couplings are applied for the monitoring and control pressure as well as the ventilation. The advantages of this system are – among other – connection at system pressure level, the easy connection to measurement control and switching devices, the leakproof connection and the integrated vibration security of the metal cap.

Media:

Hydraulic oils and mineral based fluids.
(Please check compatibility of seal material.)
For nitrogen and other inert gases upon request.

Materials:

Metal parts: stainless steel
Seals: NBR (-20 °C bis +100 °C)
FKM (-20 °C bis +200 °C)(**standard**)
EPDM (-40°C bis +150 °C)
Hose: polyamide (-35 °C bis +100 °C);

Pressure:

Maximum working pressure (PN) of the test couplings - 630 bar at 4-fold security. Connection under pressure up to 400 bar. For the union pieces please observe the instructions given by the corresponding producer.

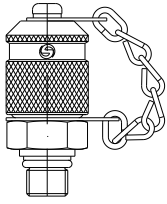
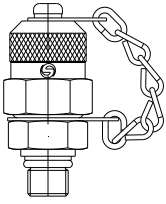
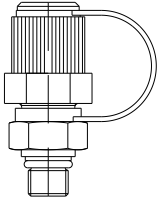

design types of caps

type B (round)	type A (universal)	type A (universal) plastic
		
standard: incl. vibration security		(temperature range -20°C to +100°C)

port connection and seals

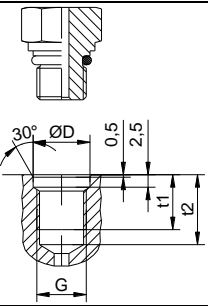
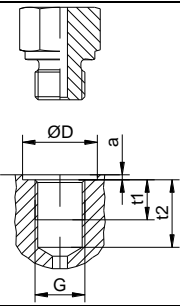
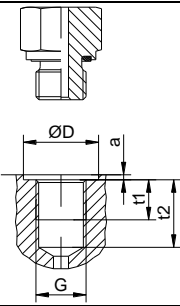
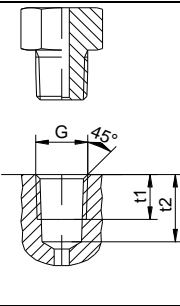
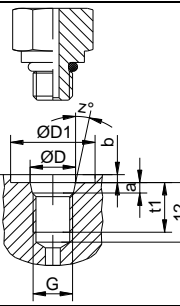
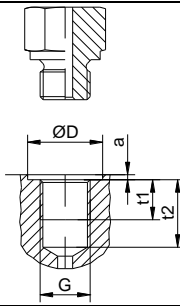
type 1	type 2	type 3	type 4	type 5	type 6
					
Design types of port connection and seals please see annex.					

test coupling – stainless steel series M16x2 – valve function by piston seals made of FKM

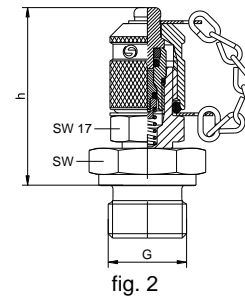
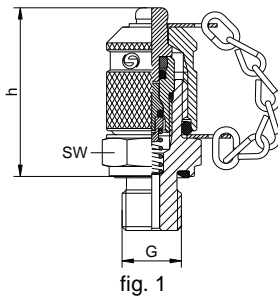

G	PN	SW	h	fig.	sealing	main parts	part number
M10x1		17	38	1	o-ring type 1	1.4571	1-912-22-22-660
M12x1,5		17	39	1	soft sealing type 3	1.4571	1-912-23-12-660
M14x1,5		19	37	1	soft sealing type 3	1.4571	1-912-24-12-660
G 1/8		17	39	1	soft sealing type 3	1.4571	1-912-28-12-660
G 1/4		19	37	1	metallic sealing type 2	1.4571	1-912-29-32-660
G 1/4		19	37	1	soft sealing type 3	1.4571	1-912-29-12-660 ¹⁾
G 3/8		22	37	1	metallic sealing type 2	1.4571	1-912-30-32-660
G 3/8		22	37	1	soft sealing type 3	1.4571	1-912-30-12-660
G 1/2		27	39	1	metallic sealing type 2	1.4571	1-912-31-32-660
G 1/2		27	39	1	soft sealing type 3	1.4571	1-912-31-12-660
Rk 1/8*		17	36	1	thread type 4	1.4571	1-912-33-02-660
Rk 1/4*		19	35	1	thread type 4	1.4571	1-912-34-02-660
7/16-20 UNF		17	38	1	o-ring type 5	1.4571	1-912-39-32-660
9/16-18 UNF		19	38	1	o-ring type 5	1.4571	1-912-40-32-660
1/8 NPT		17	36	1	thread type 4	1.4571	1-912-43-02-660
1/4 NPT		17	35	1	thread type 4	1.4571	1-912-44-02-660

For metal cap type A (universal) with vibration security	replace 660 by	650
For metal cap type B (round) without vibration security	replace 660 by	080
For metal cap type A (universal) without vibration security	replace 660 by	070
For yellow plastic cap type A (universal) without vibration security	replace 660 by	100
¹⁾ For body made from stainless steel 1.4305 add -05 at the end		

*acc. DIN 3858

**fitting with test coupling – stainless steel
series M16x2 – valve function by piston
seals made from FKM**

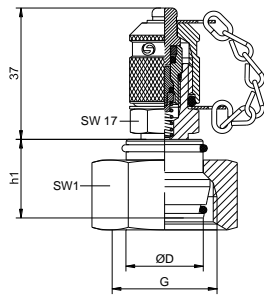

fig. 1

type DKO

test coupling with 24° taper adapter

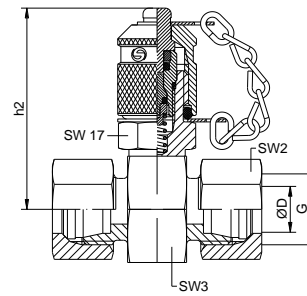

fig. 2

type GE

test coupling with straight fitting

type	PN	tube ØD	G	h1	h2	SW1	SW2	SW3	material main parts	type DKO part number	fig.	type GE part number	fig.
L	315	6	M12x1,5			14			1.4571	1-914-00-00-660	1	1-916-00-00-660	2
		8	M14x1,5			17			1.4571	1-914-02-00-660	1	1-916-02-00-660	2
		10	M16x1,5			19			1.4571	1-914-04-00-660	1	1-916-04-00-660	2
	160	12	M18x1,5			22			1.4571	1-914-06-00-660	1	1-916-06-00-660	2
		15	M22x1,5			27			1.4571	1-914-09-00-660	1	1-916-09-00-660	2
		18	M26x1,5			32			1.4571	1-914-11-00-660	1	1-916-11-00-660	2
		22	M30x2			36			1.4571	1-914-13-00-660	1	1-916-13-00-660	2
		28	M36x2			41			1.4571	1-914-15-00-660	1	1-916-15-00-660	2
		35	M45x2			50			1.4571	1-914-17-00-660	1	1-916-17-00-660	2
S	630	42	M52x2			60			1.4571	1-914-19-00-660	1	1-916-19-00-660	2
		6	M14x1,5			17			1.4571	1-914-01-00-660	1	1-916-01-00-660	2
		8	M16x1,5			19			1.4571	1-914-03-00-660	1	1-916-03-00-660	2
	400	10	M18x1,5			22			1.4571	1-914-05-00-660	1	1-916-05-00-660	2
		12	M20x1,5			24			1.4571	1-914-07-00-660	1	1-916-07-00-660	2
		14	M22x1,5			27			1.4571	1-914-08-00-660	1	1-916-08-00-660	2
		16	M24x1,5			30			1.4571	1-914-10-00-660	1	1-916-10-00-660	2
		20	M30x2			36			1.4571	1-914-12-00-660	1	1-916-12-00-660	2
		25	M36x2			46			1.4571	1-914-14-00-660	1	1-916-14-00-660	2
315	30	M42x2			50			1.4571	1-914-16-00-660	1	1-916-16-00-660	2	
	38	M52x2			60			1.4571	1-914-18-00-660	1	1-916-18-00-660	2	
For metal cap type A (universal) with vibration security replace 660 by										650		650	
For metal cap type B (round) without vibration security replace 660 by										080		080	
For metal cap type A (universal) without vibration security replace 660 by										070		070	
For yellow plastic cap type A (universal) without vibration security replace 660 by										100		100	

bulkhead pressure gauge connector – stainless steel series M16x2 – without valve function

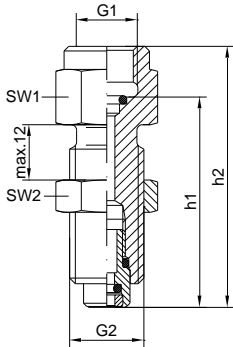

G1	SW1	SW2	h1	h2	G2	sealing	main parts	part number
G 1/4	19	19	46	57	M16x2	o-ring	1.4571	1-939-29-22-240
G 1/2	27	24	49	66	M16x2	o-ring	1.4571	1-939-31-22-240
1/4 NPT	19	19	-	58	M16x2	thread	1.4571	1-939-44-02-240
1/2 NPT	19	24	-	66	M16x2	thread	1.4571	1-939-46-02-240

direct pressure gauge connector – stainless steel series M16x2 – without valve function

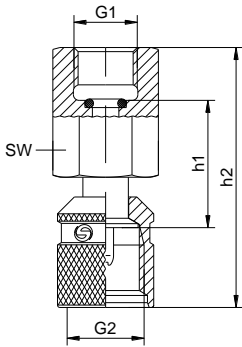

G1	SW	h1	h2	G2	sealing	main parts	part number
G 1/4	19	27	54	M16x2	o-ring	1.4305	1-940-29-22-080
G 1/2	27	25	58	M16x2	o-ring	1.4305	1-940-31-22-080
1/4 NPT	19	-	53	M16x2	thread	1.4305	1-940-44-02-080
1/2 NPT	27	-	59	M16x2	thread	1.4305	1-940-46-02-080

For design with cap type A (universal) replace 080 by

070

high pressure hose – stainless steel series M16x2 seals made from FKM

Max. working pressure:
630 bar

Pressure / t° factor:
at 20°C 100%
at 40°C 95%
at 60°C 90%
at 80°C 80%
at 100°C 70%

Further details please
see section hoses and
connectors

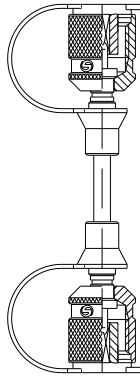

series M16x2

series M16x2	length L ¹⁾ acc. DIN 20066	with cap type B	with cap type A	material connector
	200 mm	1-971-07-07-010	1-971-06-06-010	1.4305
	400 mm	1-971-07-07-040	1-971-06-06-040	1.4305
	630 mm	1-971-07-07-060	1-971-06-06-060	1.4305
	800 mm	1-971-07-07-080	1-971-06-06-080	1.4305
	1000 mm	1-971-07-07-090	1-971-06-06-090	1.4305
	1500 mm	1-971-07-07-100	1-971-06-06-100	1.4305
	2000 mm	1-971-07-07-110	1-971-06-06-110	1.4305
	2500 mm	1-971-07-07-120	1-971-06-06-120	1.4305
	3200 mm	1-971-07-07-130	1-971-06-06-130	1.4305
	4000 mm	1-971-07-07-140	1-971-06-06-140	1.4305

¹⁾ other length upon
request

For hose end connectors made from 1.4571 07-07 change to 0H-0H 06-06 change to 87-87

single parts for test hoses

view	no.	G	SW	DN	part number	material	description
	06	M16x2	19	2	2-970-06-02-001	1.4305	connector for test coupling metal cap type A (universal)
	87	M16x2	19	2	2-970-87-02-001	1.4571	inclusive ferrule*
	07	M16x2	-	2	2-970-07-02-001	1.4305	connector for test coupling metal cap type B (round)
	0H	M16x2	-	2	2-970-0H-02-001	1.4571	inclusive ferrule*
	52	G 1/4	17	2	2-970-52-02-004	1.4305	pressure gauge connector with Whitworth - thread
	88	G 1/4	17	2	2-970-88-02-001	1.4571	sealing to pressure gauge by o-ring inclusive ferrule

For connector without ferrule replace 970 by 971

* incl. strap

For hose material please see chapter hoses and connectors.
The information on the definition of the hose assembly lengths, please see the annex.



Application:

Spradow test couplings are applied for the monitoring and control pressure as well as the ventilation. The advantages of this system are – among other – connection at system pressure level, the easy connection to measurement control and switching devices, the leakproof connection and the integrated vibration security of the metal cap.

Media:

Hydraulic oils and mineral based fluids.
(Please check compatibility of seal material.)
For nitrogen and other inert gases upon request.

Materials:

Metal parts: Steel, Stainless steel upon request
Seals: NBR (-20 °C to +100 °C)
FKM (-20 °C to +200 °C)
EPDM (-40 °C to +150 °C)
Hose: polyamide (-35 °C to +100 °C)

Surface:

Zinc nickel, black, CrVI-free.

Pressure:

Maximum working pressure (PN) for the test couplings - 630 bar at 4-fold security. Connection under pressure up to 630 bar. For the union pieces please observe the instructions given by the corresponding producer.

design types of caps

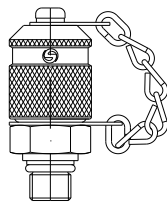
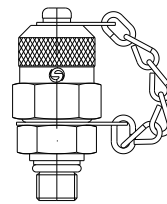
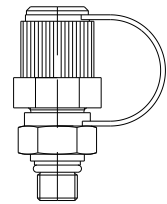
type B (round)	type A (universal)	type A (universal) plastic
		
standard: incl. vibration security		(temperature range -20°C to +100°C)

port connection and seals

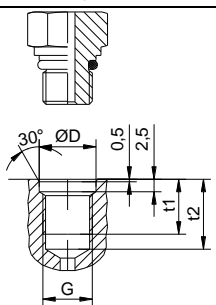
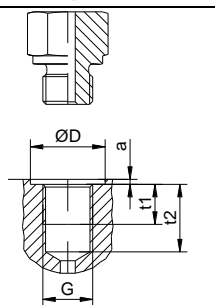
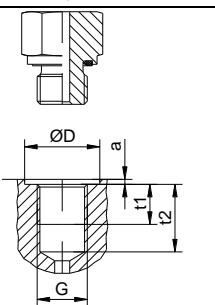
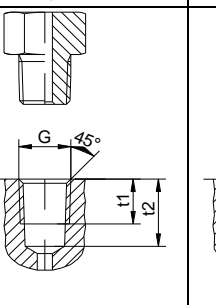
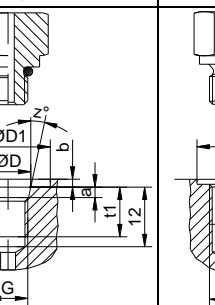
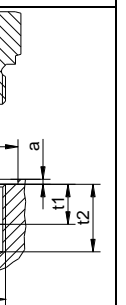
type 1	type 2	type 3	type 4	type 5	type 6
					
Design types of port connection and seals please see annex.					

Other dimensions on request. We reserve the right to change the technical performance. All dimensions in mm.

test coupling series M16x1,5 – valve function by ball

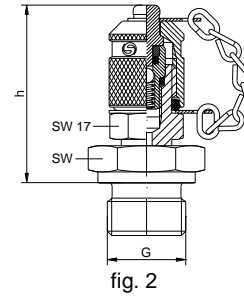
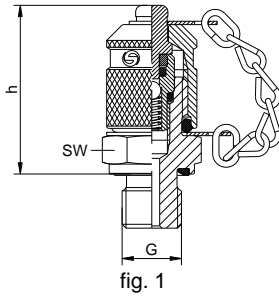

G	PN	SW	h	fig.	sealing	part number (NBR)	part number (FKM)
M8x1	250	17	38	1	o-ring type 1	1-906-20-21-630	1-906-20-22-630
M8x1		17	38	1	metallic sealing type 2	1-906-20-30-630	1-906-20-32-630
M10x1	630	17	38	1	o-ring type 1	1-906-22-21-630	1-906-22-22-630
M10x1	400	17	38	1	metallic sealing type 2	1-906-22-30-630	1-906-22-32-630
M10x1	400	17	39	1	soft sealing type 3	1-906-22-11-630	1-906-22-12-630
M10x1		38		1	metallic sealing type 6	1-906-22-40-630	1-906-22-42-630
M10x1,25		38		1	o-ring type 1	1-906-49-21-630	1-906-49-22-630
M10x1,25		38		1	soft sealing type 3	1-906-49-11-630	1-906-49-12-630
M12x1,5	630	17	38	1	metallic sealing type 2	1-906-23-30-630	1-906-23-32-630
M12x1,5	630	17	39	1	soft sealing type 3	1-906-23-11-630	1-906-23-12-630
M14x1,5	630	19	37	1	metallic sealing type 2	1-906-24-30-630	1-906-24-32-630
M14x1,5	630	19	37	1	soft sealing type 3	1-906-24-11-630	1-906-24-12-630
M14x1,5	630	19	38	1	o-ring type 5	1-906-24-61-630	1-906-24-62-630
M16x1,5	630	22	37	1	metallic sealing type 2	1-906-25-30-630	1-906-25-32-630
M16x1,5	630	22	37	1	soft sealing type 3	1-906-25-11-630	1-906-25-12-630
M18x1,5	24	39	1	1	metallic sealing type 2	1-906-26-30-630	1-906-26-32-630
M18x1,5	24	39	1	1	soft sealing type 3	1-906-26-11-630	1-906-26-12-630
M20x1,5	27	39	1	1	metallic sealing type 2	1-906-51-30-630	1-906-51-32-630
M20x1,5	27	39	1	1	soft sealing type 3	1-906-51-11-630	1-906-51-11-630
M22x1,5	27	39	1	1	metallic sealing type 2	1-906-27-30-630	1-906-27-32-630
M22x1,5	27	39	1	1	soft sealing type 3	1-906-27-11-630	1-906-27-12-630
M26x1,5	32	49	2	2	metallic sealing type 2	1-911-52-30-630	1-911-52-32-630
M27x2	36	49	2	2	metallic sealing type 2	1-911-53-30-630	1-911-53-32-630
M33x2	41	49	2	2	metallic sealing type 2	1-911-54-30-630	1-911-54-32-630
M42x2	50	50	2	2	metallic sealing type 2	1-911-55-30-630	1-911-55-32-630
M48x2	60	50	2	2	metallic sealing type 2	1-911-56-30-630	1-911-56-32-630
G 1/8	400	17	38	1	metallic sealing type 2	1-906-28-30-630	1-906-28-32-630
G 1/8	400	17	39	1	soft sealing type 3	1-906-28-11-630	1-906-28-12-630
G 1/4	630	19	37	1	metallic sealing type 2	1-906-29-30-630	1-906-29-32-630
G 1/4	630	19	37	1	soft sealing type 3	1-906-29-11-630	1-906-29-12-630
G 1/4		37		1	metallic sealing type 6	1-906-29-40-630	1-906-29-42-630
G 3/8	630	22	37	1	metallic sealing type 2	1-906-30-30-630	1-906-30-32-630
G 3/8	630	22	37	1	soft sealing type 3	1-906-30-11-630	1-906-30-12-630
G 1/2		39		1	metallic sealing type 2	1-906-31-30-630	1-906-31-32-630
G 1/2	630	27	39	1	soft sealing type 3	1-906-31-11-630	1-906-31-12-630
G 3/4		40		1	metallic sealing type 2	1-906-32-30-630	1-906-32-32-630
G 1		48		2	metallic sealing type 2	1-911-57-30-630	1-911-57-32-630
G 1 1/4		50		2	metallic sealing type 2	1-911-58-30-630	1-911-58-32-630
G 1 1/2		60		2	metallic sealing type 2	1-911-59-30-630	1-911-59-32-630
Rk 1/8*	400	17	36	1	thread type 4	1-906-33-00-630	1-906-33-02-630
Rk 1/4*	630	17	35	1	thread type 4	1-906-34-00-630	1-906-34-02-630
Rk 3/8*		19	35	1	thread type 4	1-906-35-00-630	1-906-35-02-630
5/16-24 UNF	400	17	38	1	o-ring type 5	1-906-38-30-630	1-906-38-32-630
7/16-20 UNF	630	17	38	1	o-ring type 5	1-906-39-30-630	1-906-39-32-630
1/2-20 UNF	630	17	38	1	o-ring type 5	1-906-61-30-630	1-906-61-32-630
9/16-18 UNF	630	19	38	1	o-ring type 5	1-906-40-30-630	1-906-40-32-630
3/4-16 UNF	630	27	40	1	o-ring type 5	1-906-41-30-630	1-906-41-32-630
1/8 NPT	400	17	36	1	thread type 4	1-906-43-00-630	1-906-43-02-630
1/4 NPT	630	17	35	1	thread type 4	1-906-44-00-630	1-906-44-02-630
3/8 NPT		19	36	1	thread type 4	1-906-45-00-630	1-906-45-02-630
1/2 NPT		22	37	1	thread type 4	1-906-46-00-630	1-906-46-02-630

For metal cap type A (universal) with vibration security replace 630 by 620

For metal cap type B (round) **without vibration security** replace 630 by 050

For metal cap type A (universal) **without vibration security** replace 630 by 040

For yellow plastic cap type A (universal) **without vibration security** replace 630 by 110

*acc. DIN 3858

Other dimensions on request. We reserve the right to change the technical performance. All dimensions in mm.

fitting with test coupling series M16x1,5 – valve function by ball

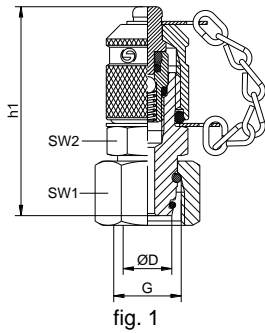

fig. 1

type DKO

test coupling with 24° taper adaptor

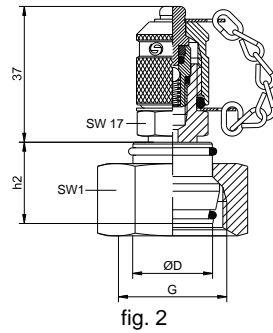

fig. 2

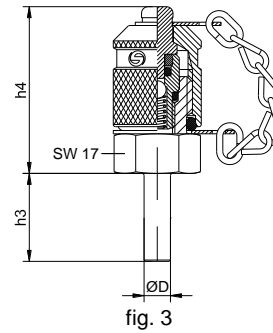

fig. 3

type BE

test coupling for compression ring fittings

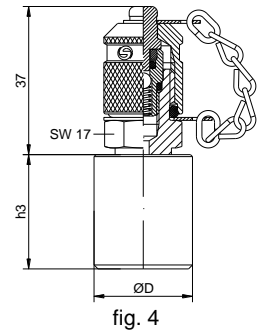

fig. 4

type PN	tube ØD	h1	h2	h3	h4	SW1	SW2	G	type DKO part number	fig.	type BE part number	fig.	
L	315	6	53	-	20	39	14	17	M12x1,5	1-908-00-10-630	1	1-909-00-00-631	3
		8	53	-	20	39	17	17	M14x1,5	1-908-02-10-630	1	1-909-02-00-631	3
		10	50	-	22	37	19	17	M16x1,5	1-908-04-10-630	1	1-909-04-00-631	3
		12	50	-	22	37	22	17	M18x1,5	1-908-06-10-630	1	1-909-06-00-631	3
		15	51	-	22	37	27	19	M22x1,5	1-908-09-00-630	1	1-909-09-00-631	3
	160	18	-	22	28	-	32	-	M26x1,5	1-908-11-00-630	2	1-909-11-00-631	4
		22	-	22	30	-	36	-	M30x2	1-908-13-00-630	2	1-909-13-00-631	4
		28	-	24	32	-	41	-	M36x2	1-908-15-00-630	2	1-909-15-00-631	4
		35	-	27	42	-	50	-	M45x2	1-908-17-00-630	2	1-909-17-00-631	4
		42	-	28	45	-	60	-	M52x2	1-908-19-00-630	2	1-909-19-00-631	4
S	630	6	54	-	20	39	17	17	M14x1,5	1-908-01-10-630	1	1-909-00-00-631	3
		8	51	-	20	39	19	17	M16x1,5	1-908-03-10-630	1	1-909-02-00-631	3
		10	51	-	22	37	22	17	M18x1,5	1-908-05-10-630	1	1-909-04-00-631	3
		12	51	-	22	37	24	17	M20x1,5	1-908-07-10-630	1	1-909-06-00-631	3
		14	-	20	22	37	27	-	M22x1,5	1-908-08-00-630	2	1-909-08-00-631	3
	400	16	-	20	28	37	30	-	M24x1,5	1-908-10-00-630	2	1-909-10-00-631	3
		20	-	25	30	-	36	-	M30x2	1-908-12-00-630	2	1-909-12-00-631	4
		25	-	27	36	-	46	-	M36x2	1-908-14-00-630	2	1-909-14-00-631	4
		30	-	29	41	-	50	-	M42x2	1-908-16-00-630	2	1-909-16-00-631	4
		315	38	-	32	48	-	60	-	M52x2	1-908-18-00-630	2	1-909-18-00-631

For metal cap type A (universal) with vibration security
 For metal cap type B (round) **without vibration security**
 For metal cap type A (universal) **without vibration security**
 For yellow plastic cap type A (universal) **without vibration security**

Design with sealings made of FKM

replace 630 by 620
 replace 630 by 050
 replace 630 by 040
 replace 630 by 110
 replace 10-630 by 12-630 or
 replace 00-630 by 02-630

replace 631 by 621
 replace 631 by 051
 replace 631 by 041
 replace 631 by 111
 replace 00-631 by 02-631

90° fitting type BE with test coupling series M16x1,5 – valve function by ball

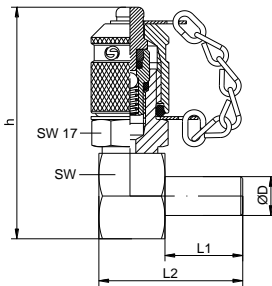

tube ØD	L1	L2	SW	h	part number (NBR)	part number (FKM)
8	20	37	22	59	1-980-03-63-080	1-980-03-63-081
10	20	37	22	59	1-980-05-63-120	1-980-05-63-121

For metal cap type A (universal) with vibration security
 For metal cap type B (round) **without vibration security**
 For metal cap type A (universal) **without vibration security**
 For yellow plastic cap type A (universal) **without vibration security**

replace 63 by 62
 replace 63 by 05
 replace 63 by 04
 replace 63 by 11

replace 63 by 62
 replace 63 by 05
 replace 63 by 04
 replace 63 by 11

Other dimensions on request. We reserve the right to change the technical performance. All dimensions in mm.

fitting with test coupling
series M16x1,5 – valve function by ball

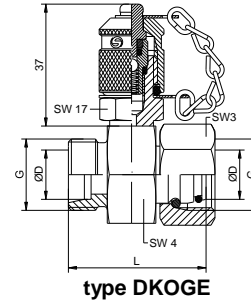
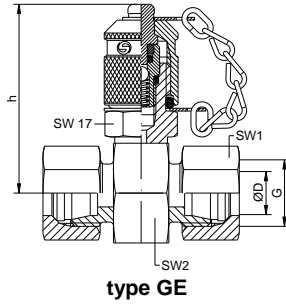

type	PN	tube ØD	G	SW1	SW2	h	L	SW3	SW4	type GE part number	type DKOGE part number
L	315	6	M12x1,5	14	22	48	43	14	24	1-910-00-00-630	1-910-20-00-631
		8	M14x1,5	17	24	49	43	17	24	1-910-02-00-630	1-910-22-00-631
		10	M16x1,5	19	24	49	45	19	24	1-910-04-00-630	1-910-24-00-631
		12	M18x1,5	22	27	51	41	22	27	1-910-06-00-630	1-910-26-00-631
		15	M22x1,5	27	30	53	43	27	30	1-910-09-00-630	1-910-29-00-631
	160	18	M26x1,5	32	32	53	54	32	32	1-910-11-00-630	1-910-31-00-631
		22	M30x2	36	36	55	57	36	36	1-910-13-00-630	1-910-33-00-631
		28	M36x2	41	41	58		upon request		1-910-15-00-630	1-910-35-00-631
		35	M45x2	50	46	60		upon request		1-910-17-00-630	1-910-37-00-631
		42	M52x2	60	55	65		upon request		1-910-19-00-630	1-910-39-00-631
S	630	6	M14x1,5	17	24	49	46	17	24	1-910-01-00-630	1-910-21-00-631
		8	M16x1,5	19	24	49	47	19	24	1-910-03-00-630	1-910-23-00-631
		10	M18x1,5	22	24	49	48	22	24	1-910-05-00-630	1-910-25-00-631
		12	M20x1,5	24	24	49	47	24	24	1-910-07-00-630	1-910-27-00-631
		14	M22x1,5	27	27	51	50	27	27	1-910-08-00-630	1-910-28-00-631
	400	16	M24x1,5	30	30	52	55	30	30	1-910-10-00-630	1-910-30-00-631
		20	M30x2	36	32	53	62	36	36	1-910-12-00-630	1-910-32-00-631
		25	M36x2	46	41	58	62	46	41	1-910-14-00-630	1-910-34-00-631
		30	M42x2	50	46	60		upon request		1-910-16-00-630	1-910-36-00-631
		35	M52x2	60	55	65		upon request		1-910-18-00-630	1-910-38-00-631

For metal cap type A (universal) with vibration security	replace 630 by 620	631 by 621
For metal cap type B (round) without vibration security	replace 630 by 050	631 by 051
For metal cap type A (universal) without vibration security	replace 630 by 040	631 by 041
For yellow plastic cap type A (universal) without vibration security	replace 630 by 110	631 by 111
Design with sealings made of FKM	replace 00-630 by 02-630	00-631 by 02-631

bulkhead coupling series M16x1,5 – valve function by ball

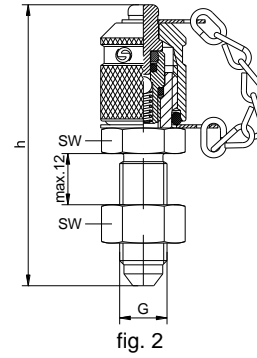
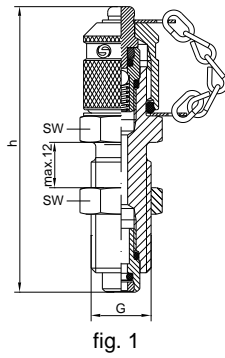

G	SW	h	fig.	part number (NBR)	part number (FKM)
M16x2	19	72	1	1-980-48-63-040	upon request
7/16-20 UNF	17	67	2	upon request	upon request
For metal cap type A (universal) with vibration security 63 by				62	62
For metal cap type B (round) without vibration security 63 by				05	05
For metal cap type A (universal) without vibration security 63 by				04	04
For metal cap type A (universal) without vibration security 63 by				11	11

Other dimensions on request. We reserve the right to change the technical performance. All dimensions in mm.

Application:

Spradow test couplings are applied for the monitoring and control pressure as well as the ventilation. The advantages of this system are – among other – connection at system pressure level, the easy connection to measurement control and switching devices, the leakproof connection and the integrated vibration security of the metal cap.

Media:

Hydraulic oils and mineral based fluids.
(Please check compatibility of seal material.)
For nitrogen and other inert gases upon request.

Materials:

Metal parts: Steel, Stainless steel upon request
Seals: NBR (-20 °C to +100 °C)
FKM (-20 °C to +200 °C)
EPDM (-40 °C to +150 °C)
Hose: polyamide (-35 °C to +100 °C)

Surface:

Zinc nickel, black, CrVI-free

Pressure:

Maximal working pressure (PN) of the test couplings – 630 bar, at 4-fold security. Connection under pressure up to 630 bar.
For the union pieces please observe the instructions given by the corresponding producer.



design types of caps

type B (round)	type A (universal)	type A (universal) plastic
standard: incl. vibration security		(temperature range -20°C to +100°C)

port connection and seals

type 1	type 2	type 3	type 4	type 5	type 6
Design types of port connection and seals please see annex.					

Other dimensions on request. We reserve the right to change the technical performance. All dimensions in mm.

test coupling series M16x1,5 – valve function by piston

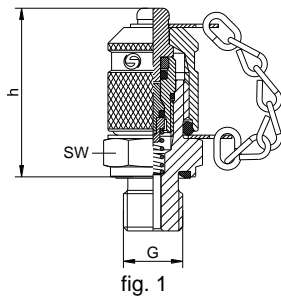

fig. 1

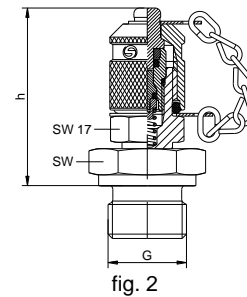

fig. 2

G	PN	SW	h	fig.	sealing	part number (NBR)	part number (FKM)
M8x1	250	17	38	1	o-ring type 1	1-Z06-20-21-630	1-Z06-20-22-630
M8x1	17	38	1		metallic sealing type 2	1-Z06-20-30-630	1-Z06-20-32-630
M10x1	630	17	38	1	o-ring type 1	1-Z06-22-21-630	1-Z06-22-22-630
M10x1	400	17	38	1	metallic sealing type 2	1-Z06-22-30-630	1-Z06-22-32-630
M10x1	400	17	39	1	soft sealing type 3	1-Z06-22-11-630	1-Z06-22-12-630
M10x1	17	38	1		metallic sealing type 6	1-Z06-22-40-630	1-Z06-22-42-630
M10x1,25	17	38	1		o-ring type 1	1-Z06-49-21-630	1-Z06-49-22-630
M10x1,25	17	38	1		soft sealing type 3	1-Z06-49-11-630	1-Z06-49-12-630
M12x1,5	630	17	38	1	metallic sealing type 2	1-Z06-23-30-630	1-Z06-23-32-630
M12x1,5	630	17	39	1	soft sealing type 3	1-Z06-23-11-630	1-Z06-23-12-630
M14x1,5	630	19	37	1	metallic sealing type 2	1-Z06-24-30-630	1-Z06-24-32-630
M14x1,5	630	19	37	1	soft sealing type 3	1-Z06-24-11-630	1-Z06-24-12-630
M14x1,5	630	19	38	1	o-ring type 5	1-Z06-24-61-630	1-Z06-24-62-630
M16x1,5	630	22	37	1	metallic sealing type 2	1-Z06-25-30-630	1-Z06-25-32-630
M16x1,5	630	22	37	1	soft sealing type 3	1-Z06-25-11-630	1-Z06-25-12-630
M18x1,5	24	39	1		metallic sealing type 2	1-Z06-26-30-630	1-Z06-26-32-630
M18x1,5	24	39	1		soft sealing type 3	1-Z06-26-11-630	1-Z06-26-12-630
M20x1,5	27	39	1		metallic sealing type 2	1-Z06-51-30-630	1-Z06-51-32-630
M20x1,5	27	39	1		soft sealing type 3	1-Z06-51-11-630	1-Z06-51-12-630
M22x1,5	27	39	1		metallic sealing type 2	1-Z06-27-30-630	1-Z06-27-32-630
M22x1,5	27	39	1		soft sealing type 3	1-Z06-27-11-630	1-Z06-27-12-630
M26x1,5	32	49	2		metallic sealing type 2	1-Z11-52-30-630	1-Z11-52-32-630
M27x2	36	49	2		metallic sealing type 2	1-Z11-53-30-630	1-Z11-53-32-630
M33x2	41	49	2		metallic sealing type 2	1-Z11-54-30-630	1-Z11-54-32-630
M42x2	50	50	2		metallic sealing type 2	1-Z11-55-30-630	1-Z11-55-32-630
M48x2	60	50	2		metallic sealing type 2	1-Z11-56-30-630	1-Z11-56-32-630
G 1/8	400	17	38	1	metallic sealing type 2	1-Z06-28-30-630	1-Z06-28-32-630
G 1/8	400	17	39	1	soft sealing type 3	1-Z06-28-11-630	1-Z06-28-12-630
G 1/4	630	19	37	1	metallic sealing type 2	1-Z06-29-30-630	1-Z06-29-32-630
G 1/4	630	19	37	1	soft sealing type 3	1-Z06-29-11-630	1-Z06-29-12-630
G 1/4	19	37	1		metallic sealing type 6	1-Z06-29-40-630	1-Z06-29-42-630
G 3/8	630	22	37	1	metallic sealing type 2	1-Z06-30-30-630	1-Z06-30-32-630
G 3/8	630	22	37	1	soft sealing type 3	1-Z06-30-11-630	1-Z06-30-12-630
G 1/2	27	39	1		metallic sealing type 2	1-Z06-31-30-630	1-Z06-31-32-630
G 1/2	630	27	39	1	soft sealing type 3	1-Z06-31-11-630	1-Z06-31-12-630
G 3/4	32	40	1		metallic sealing type 2	1-Z06-32-30-630	1-Z06-32-32-630
G 1	41	48	2		metallic sealing type 2	1-Z11-57-30-630	1-Z11-57-32-630
G 1 1/4	50	50	2		metallic sealing type 2	1-Z11-58-30-630	1-Z11-58-32-630
G 1 1/2	60	50	2		metallic sealing type 2	1-Z11-59-30-630	1-Z11-59-32-630
Rk 1/8*	400	17	36	1	thread type 4	1-Z06-33-00-630	1-Z06-33-02-630
Rk 1/4*	630	17	35	1	thread type 4	1-Z06-34-00-630	1-Z06-34-02-630
Rk 3/8*	19	35	1		thread type 4	1-Z06-35-00-630	1-Z06-35-02-630
5/16-24 UNF	400	17	38	1	o-ring type 5	1-Z06-38-30-630	1-Z06-38-32-630
7/16-20 UNF	630	17	38	1	o-ring type 5	1-Z06-39-30-630	1-Z06-39-32-630
1/2-20 UNF	630	17	38	1	o-ring type 5	1-Z06-61-30-630	1-Z06-61-32-630
9/16-18 UNF	630	19	38	1	o-ring type 5	1-Z06-40-30-630	1-Z06-40-32-630
3/4-16 UNF	630	27	40	1	o-ring type 5	1-Z06-41-30-630	1-Z06-41-32-630
1/8 NPT	400	17	36	1	thread type 4	1-Z06-43-00-630	1-Z06-43-02-630
1/4 NPT	630	17	35	1	thread type 4	1-Z06-44-00-630	1-Z06-44-02-630
3/8 NPT	19	36	1		thread type 4	1-Z06-45-00-630	1-Z06-45-02-630
1/2 NPT	22	37	1		thread type 4	1-Z06-46-00-630	1-Z06-46-02-630
For metal cap type A (universal) with vibration security, replace 630 by						620	620
For metal cap type B (round) without vibration security , replace 630 by						050	050
For metal cap type A (universal) without vibration security , replace 630 by						040	040
For yellow plastic cap type A (universal) without vibration security , replace 630 by						110	110

*acc. DIN 3858

Other dimensions on request. We reserve the right to change the technical performance. All dimensions in mm.

fittings with test coupling series M16x1,5 – valve function by piston

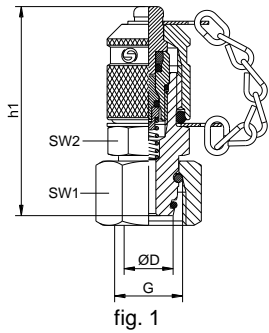

fig. 1

type DKO

test coupling with 24° taper adapter

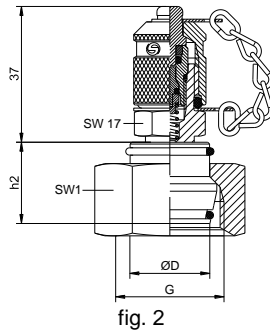

fig. 2

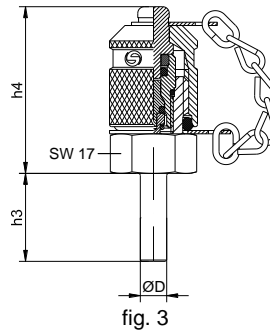

fig. 3

type BE

test coupling for compression ring fittings

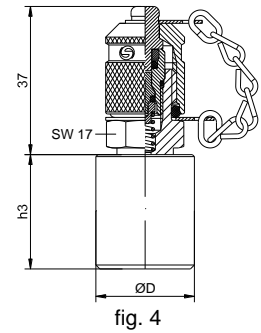

fig. 4

type	PN	tube ØD	h1	h2	h3	h4	SW1	SW2	G	type DKO part number	fig.	type BE part number	fig.
L	315	6	53	-	20	39	14	17	M12x1,5	1-Z08-00-10-630	1	1-Z09-00-00-631	3
		8	53	-	20	39	17	17	M14x1,5	1-Z08-02-10-630	1	1-Z09-02-00-631	3
		10	50	-	22	37	19	17	M16x1,5	1-Z08-04-10-630	1	1-Z09-04-00-631	3
		12	50	-	22	37	22	17	M18x1,5	1-Z08-06-10-630	1	1-Z09-06-00-631	3
		15	51	-	22	37	27	19	M22x1,5	1-Z08-09-00-630	1	1-Z09-09-00-631	3
	160	18	-	22	28	-	32	-	M26x1,5	1-Z08-11-00-630	2	1-Z09-11-00-631	4
		22	-	22	30	-	36	-	M30x2	1-Z08-13-00-630	2	1-Z09-13-00-631	4
		28	-	24	32	-	41	-	M36x2	1-Z08-15-00-630	2	1-Z09-15-00-631	4
		35	-	27	42	-	50	-	M45x2	1-Z08-17-00-630	2	1-Z09-17-00-631	4
		42	-	28	45	-	60	-	M52x2	1-Z08-19-00-630	2	1-Z09-19-00-631	4
S	630	6	54	-	20	39	17	17	M14x1,5	1-Z08-01-10-630	1	1-Z09-00-00-631	3
		8	51	-	20	39	19	17	M16x1,5	1-Z08-03-10-630	1	1-Z09-02-00-631	3
		10	51	-	22	37	22	17	M18x1,5	1-Z08-05-10-630	1	1-Z09-04-00-631	3
		12	51	-	22	37	24	17	M20x1,5	1-Z08-07-10-630	1	1-Z09-06-00-631	3
		14	-	20	22	37	27	-	M22x1,5	1-Z08-08-00-630	2	1-Z09-08-00-631	3
	400	16	-	20	28	37	30	-	M24x1,5	1-Z08-10-00-630	2	1-Z09-10-00-631	3
		20	-	25	30	-	36	-	M30x2	1-Z08-12-00-630	2	1-Z09-12-00-631	4
		25	-	27	36	-	46	-	M36x2	1-Z08-14-00-630	2	1-Z09-14-00-631	4
		30	-	29	41	-	50	-	M42x2	1-Z08-16-00-630	2	1-Z09-16-00-631	4
		315	38	-	32	48	-	60	-	M52x2	1-Z08-18-00-630	2	1-Z09-18-00-631

For metal cap type A (universal) with vibration security
 For metal cap type B (round) **without vibration security**
 For metal cap type A (universal) **without vibration security**
 For yellow plastic cap type A (universal) **without vibration security**

Design with sealings made of FKM

replace 630 by 620
 replace 630 by 050
 replace 630 by 040
 replace 630 by 110

replace 10-630 by 12-630 or
 00-630 by 02-630

replace 631 by 621
 replace 631 by 051
 replace 631 by 041
 replace 631 by 111

replace 00-631 by 02-631

90° fitting type BE with test coupling series M16x1,5 – valve function by piston

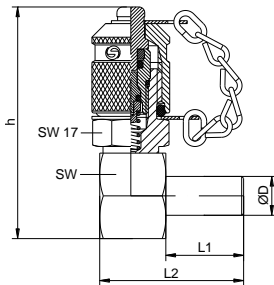

tube ØD	L1	L2	SW	h	part number (NBR)	part number (FKM)
8	20	37	22	59	1-Z80-03-63-080	1-Z80-03-63-081
10	20	37	22	59	1-Z80-05-63-120	1-Z80-05-63-121

For metal cap type A (universal) with vibration security replace 63 by 62
 For metal cap type B (round) **without vibration security** replace 63 by 05
 For metal cap type A (universal) **without vibration security** replace 63 by 04
 For yellow plastic cap type A (universal) **without vibration security** replace 63 by 11

Other dimensions on request. We reserve the right to change the technical performance. All dimensions in mm.

fitting with test coupling series M16x1,5 – valve function by piston

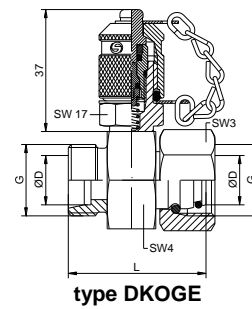
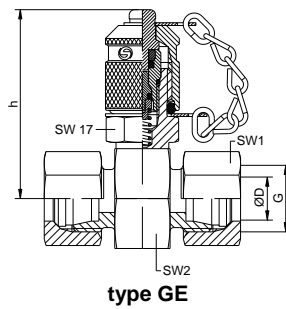

type	PN	tube ØD	G	SW1	SW2	h	L	SW3	SW4	type GE part number	type DKOGE part number
L	315	6	M12x1,5	14	22	48	43	14	24	1-Z10-00-00-630	1-Z10-20-00-631
		8	M14x1,5	17	24	49	43	17	24	1-Z10-02-00-630	1-Z10-22-00-631
		10	M16x1,5	19	24	49	45	19	24	1-Z10-04-00-630	1-Z10-24-00-631
		12	M18x1,5	22	27	51	41	22	27	1-Z10-06-00-630	1-Z10-26-00-631
		15	M22x1,5	27	30	53	43	27	30	1-Z10-09-00-630	1-Z10-29-00-631
		18	M26x1,5	32	32	53	54	32	32	1-Z10-11-00-630	1-Z10-31-00-631
	160	22	M30x2	36	36	55	57	36	36	1-Z10-13-00-630	1-Z10-33-00-631
		28	M36x2	41	41	58		upon request		1-Z10-15-00-630	1-Z10-35-00-631
		35	M45x2	50	46	60		upon request		1-Z10-17-00-630	1-Z10-37-00-631
		42	M52x2	60	55	65		upon request		1-Z10-19-00-630	1-Z10-39-00-631
S	630	6	M14x1,5	17	24	49	46	17	24	1-Z10-01-00-630	1-Z10-21-00-631
		8	M16x1,5	19	24	49	47	19	24	1-Z10-03-00-630	1-Z10-23-00-631
		10	M18x1,5	22	24	49	48	22	24	1-Z10-05-00-630	1-Z10-25-00-631
		12	M20x1,5	24	24	49	47	24	24	1-Z10-07-00-630	1-Z10-27-00-631
		14	M22x1,5	27	27	51	50	27	27	1-Z10-08-00-630	1-Z10-28-00-631
		16	M24x1,5	30	30	52	55	30	30	1-Z10-10-00-630	1-Z10-30-00-631
	400	20	M30x2	36	32	53	62	36	36	1-Z10-12-00-630	1-Z10-32-00-631
		25	M36x2	46	41	58	62	46	41	1-Z10-14-00-630	1-Z10-34-00-631
		30	M42x2	50	46	60		upon request		1-Z10-16-00-630	1-Z10-36-00-631
		38	M52x2	60	55	65		upon request		1-Z10-18-00-630	1-Z10-38-00-631
For metal cap type A (universal) with vibration security										replace 630 by 620	replace 631 by 621
For metal cap type B (round) without vibration security										replace 630 by 050	replace 631 by 051
For metal cap type A (universal) without vibration security										replace 630 by 040	replace 631 by 041
For yellow plastic cap type A (universal) without vibration security										replace 630 by 110	replace 631 by 111
Design with sealings made of FKM										replace 00-630 by 02-630	replace 00-631 by 02-631

bulkhead coupling series M16x1,5 – valve function by piston

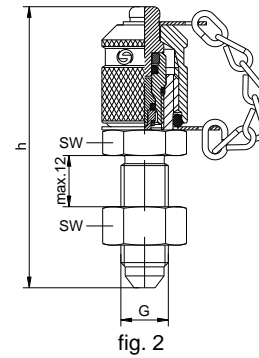
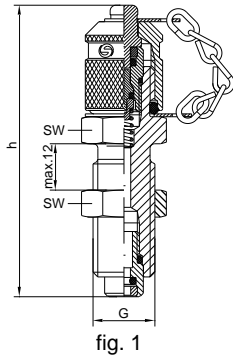

G	SW	h	fig.	part number (NBR)	part number (FKM)
M16x2	19	72	1	1-Z80-48-63-040	upon request
7/16-20 UNF	17	67	2	upon request	upon request
For metal cap type A (universal) with vibration security replace 63 by				62	62
For metal cap type B (round) without vibration security replace 63 by				05	05
For metal cap type A (universal) without vibration security replace 63 by				04	04
For yellow plastic cap type A (universal) without vibration security replace 63 by				11	11

M16x1,5 - Anschlüsse und Adapter

bulkhead pressure gauge connector series M16x1,5 – without valve function

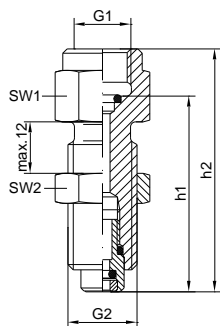

G1	SW1	SW2	h1	h2	G2	sealing	part number (NBR)	part number (FKM)
G 1/4	19	19	46	57	M16x1,5	o-ring	1-918-29-01-250	1-918-29-21-250
G 1/2	27	24	49	66	M16x1,5	o-ring	1-918-31-01-250	1-918-31-21-250

For design with damping element replace 918 by 930 930 930

direct pressure gauge connector series M16x1,5 – without valve function

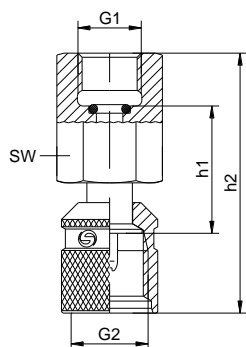

G1	SW	h1	h2	G2	sealing	part number (NBR)	part number (FKM)
G 1/4	19	27	54	M16x1,5	o-ring	1-927-29-01-050	1-927-29-21-050
G 1/2	27	25	58	M16x1,5	o-ring	1-927-31-01-050	1-927-31-21-050
1/4 NPT	19	-	53	M16x1,5	thread	1-927-44-00-050	1-927-44-20-050

For metal cap type A (universal) replace 050 by 040 040 040
 For design with damping element replace 927 by 929 929 929

high pressure hose

Max. working pressure:
up to 630 bar

Pressure / t° factor:
at 20°C 100%
at 40°C 95%
at 60°C 90%
at 80°C 80%
at 100°C 70%

Further details please see
section hoses and con-
nectors

series M16x1,5

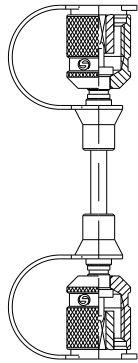

series M16x1,5

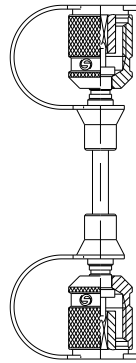

series M16x1,5

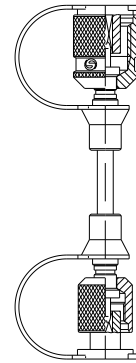

series M16x1,5

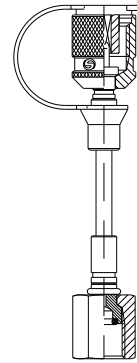

series M16x1,5

series M16x2

series S12x1,5

pressure gauge
connector G 1/4 ²⁾

length L ¹⁾ acc. DIN 20066	part number			
200	1-971-10-10-010	1-971-04-10-010	1-971-10-12-010	1-971-02-10-010
400	1-971-10-10-040	1-971-04-10-040	1-971-10-12-040	1-971-02-10-040
630	1-971-10-10-060	1-971-04-10-060	1-971-10-12-060	1-971-02-10-060
800	1-971-10-10-080	1-971-04-10-080	1-971-10-12-080	1-971-02-10-080
1000	1-971-10-10-090	1-971-04-10-090	1-971-10-12-090	1-971-02-10-090
1500	1-971-10-10-100	1-971-04-10-100	1-971-10-12-100	1-971-02-10-100
2000	1-971-10-10-110	1-971-04-10-110	1-971-10-12-110	1-971-02-10-110
2500	1-971-10-10-120	1-971-04-10-120	1-971-10-12-120	1-971-02-10-120
3200	1-971-10-10-130	1-971-04-10-130	1-971-10-12-130	1-971-02-10-130
4000	1-971-10-10-140	1-971-04-10-140	1-971-10-12-140	1-971-02-10-140

¹⁾ Other lengths upon request

Further connectors please see chapter
hoses and connectors

²⁾ Connection thread G¹/₂,
¹/₄ NPT and ¹/₂ NPT upon request.

The information on the definition of the hose assembly lengths, please see the annex.

hose connector series M16x1,5 – without valve function

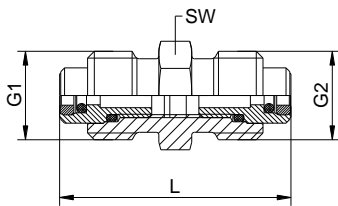

G1	SW	L	G2	part number (NBR)	part number (FKM)
M16x2	17	42	M16x1,5	1-980-48-00-030	upon request
M16x1,5	17	42	M16x1,5	1-980-25-00-030	upon request

Application:

Spradow test couplings are applied for monitoring and control pressure as well as the ventilation. The advantages of this system are - among other - connection at system pressure level, the easy connection to measurement control and switching devices, the leakproof connection and the integrated vibration security of the metal cap.

Media:

Hydraulic oils and mineral based fluids.
(Please check compatibility of seal material.)
For nitrogen and other inert gases upon request.

Materials:

Metal parts: Steel, Stainless steel upon request
Seals: NBR (-20 °C to +100 °C)
FKM (-20 °C to +200 °C)
EPDM (-40 °C to +150 °C)
Hose: polyamide (-35 °C to +100 °C)

Surface:

Zinc nickel, transparent, CrVI-free.

Pressure:

Maximum working pressure (PN) of the test couplings - 630 bar, at 3-fold security. Connection under pressure up to 400 bar. For the union pieces please observe the instructions given by the corresponding producer.

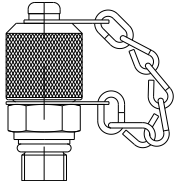
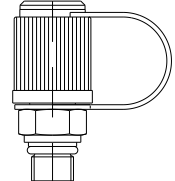

design types of caps

type B (round)	type B (round) plastic
	
standard: incl. vibration security	(temperature range -20°C to +100°C)

port connection and seals

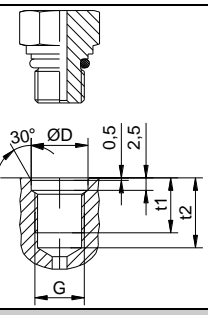
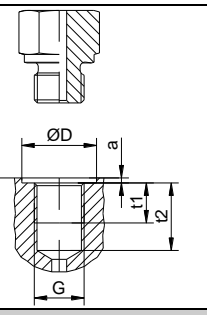
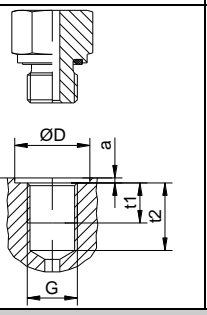
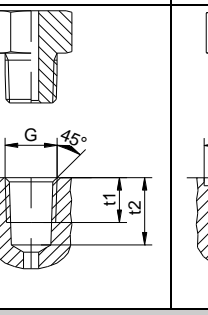
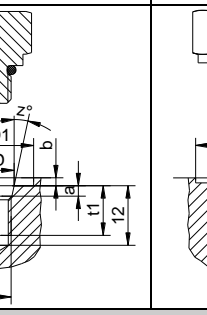
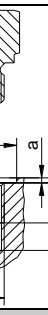
type 1	type 2	type 3	type 4	type 5	type 6
					
Design types of port connection and seals please see annex.					

Other dimensions on request. We reserve the right to change the technical performance. All dimensions in mm.

test coupling series S12x1,5 – valve function by piston

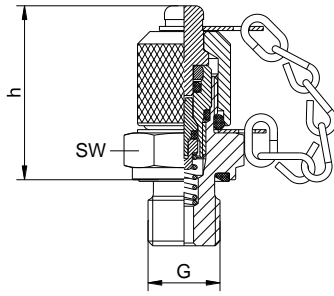

fig. 1

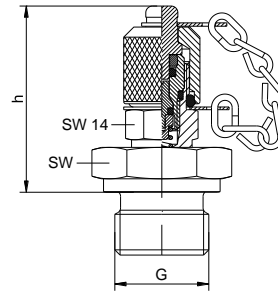

fig. 2

G	PN	SW	h	fig.	sealing	part number (NBR)	part number (FKM)
M8x1		14	38	1	metallic sealing type 2	1-S06-20-30-680-CF	1-S06-20-32-680-CF
M10x1	630	14	32	1	o-ring type 1	1-S06-22-21-680-CF	1-S06-22-22-680-CF
M10x1		14	38	1	metallic sealing type 2	1-S06-22-30-680-CF	1-S06-22-32-680-CF
M12x1,5		17	32	1	metallic sealing type 2	1-S06-23-30-680-CF	1-S06-23-32-680-CF
M12x1,5	630	17	34	1	soft sealing type 3	1-S06-23-11-680-CF	1-S06-23-12-680-CF
M14x1,5		19	33	1	metallic sealing type 2	1-S06-24-30-680-CF	1-S06-24-32-680-CF
M14x1,5		19	34	1	soft sealing type 3	1-S06-24-11-680-CF	1-S06-24-12-680-CF
M14x1,5		19	34	1	o-ring type 5	1-S06-24-61-680-CF	1-S06-24-62-680-CF
M16x1,5		22	32	1	metallic sealing type 2	1-S06-25-30-680-CF	1-S06-25-32-680-CF
M18x1,5		24	42	2	metallic sealing type 2	1-S11-26-30-680-CF	1-S11-26-32-680-CF
M18x1,5		24	42	2	soft sealing type 3	1-S11-26-11-680-CF	1-S11-26-12-680-CF
M20x1,5		27	42	2	metallic sealing type 2	1-S11-51-30-680-CF	1-S11-51-32-680-CF
M20x1,5		27	42	2	soft sealing type 3	1-S11-51-11-680-CF	1-S11-51-12-680-CF
M22x1,5		27	42	2	metallic sealing type 2	1-S11-27-30-680-CF	1-S11-27-32-680-CF
M22x1,5		27	42	2	soft sealing type 3	1-S11-27-11-680-CF	1-S11-27-12-680-CF
M26x1,5		32	43	2	metallic sealing type 2	1-S11-52-30-680-CF	1-S11-52-32-680-CF
M27x2		36	43	2	metallic sealing type 2	1-S11-53-30-680-CF	1-S11-53-32-680-CF
M33x2		41	43	2	metallic sealing type 2	1-S11-54-30-680-CF	1-S11-54-32-680-CF
M42x2		50	44	2	metallic sealing type 2	1-S11-55-30-680-CF	1-S11-55-32-680-CF
M48x2		60	44	2	metallic sealing type 2	1-S11-56-30-680-CF	1-S11-56-32-680-CF
G 1/8		14	38	1	metallic sealing type 2	1-S06-28-30-680-CF	1-S06-28-32-680-CF
G 1/8	400	14	39	1	soft sealing type 3	1-S06-28-11-680-CF	1-S06-28-12-680-CF
G 1/4		19	35	1	metallic sealing type 2	1-S06-29-30-680-CF	1-S06-29-32-680-CF
G 1/4	630	19	35	1	soft sealing type 3	1-S06-29-11-680-CF	1-S06-29-12-680-CF
G 1/2		27	42	2	metallic sealing type 2	1-S11-31-30-680-CF	1-S11-31-32-680-CF
G 1/2		27	42	2	soft sealing type 3	1-S11-31-11-680-CF	1-S11-31-12-680-CF
G 3/4		32	43	2	metallic sealing type 2	1-S11-32-30-680-CF	1-S11-32-32-680-CF
G 1		41	43	2	metallic sealing type 2	1-S11-57-30-680-CF	1-S11-57-32-680-CF
G 1 1/4		50	44	2	metallic sealing type 2	1-S11-58-30-680-CF	1-S11-58-32-680-CF
G 1 1/2		60	44	2	metallic sealing type 2	1-S11-59-30-680-CF	1-S11-59-32-680-CF
Rk 1/8*		14	33	1	thread type 4	1-S06-33-00-680-CF	1-S06-33-02-680-CF
Rk 1/4*		14	30	1	thread type 4	1-S06-34-00-680-CF	1-S06-34-02-680-CF
7/16-20 UNF	630	14	32	1	o-ring type 5	1-S06-39-30-680-CF	1-S06-39-32-680-CF
1/8 NPT	400	14	33	1	thread type 4	1-S06-43-00-680-CF	1-S06-43-02-680-CF
1/4 NPT	630	14	29	1	thread type 4	1-S06-44-00-680-CF	1-S06-44-02-680-CF
1/2 NPT		22	31	1	thread type 4	1-S06-46-00-680-CF	1-S06-46-02-680-CF
For yellow plastic cap without vibration security replace 680 by						260	260
For metal cap without vibration security replace 680 by						290	290

*acc. DIN 3858

fitting with test coupling series S12x1,5 – valve function by piston

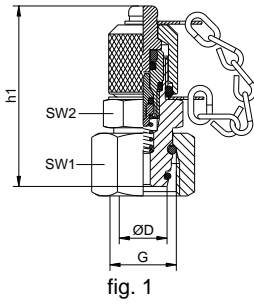

fig. 1

type DKO

test coupling with 24° taper adaptor

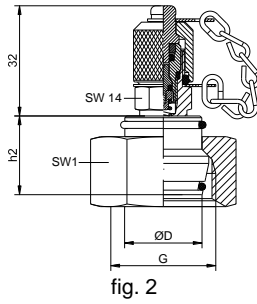

fig. 2

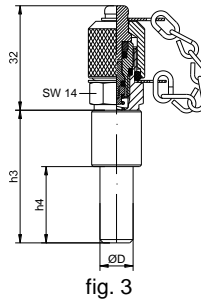

fig. 3

type BE

test coupling for compression ring fittings

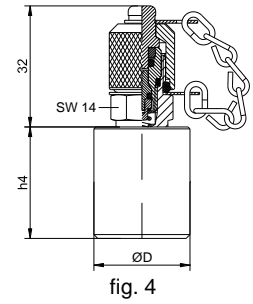

fig. 4

type PN	tube ØD	h1	h2	h3	h4	SW1	SW2	G	type DKO part number	fig.	type BE part number	fig.
L	315	6	47	-	38	20	14	17	M12x1,5	1	1-S09-00-00-681-CF	3
		8	47	-	38	20	17	17	M14x1,5	1	1-S09-02-00-681-CF	3
		10	45	-	40	22	19	17	M16x1,5	1	1-S09-04-00-681-CF	3
		12	45	-	40	22	22	17	M18x1,5	1	1-S09-06-00-681-CF	3
	160	15	46	-	-	28	27	19	M22x1,5	1	1-S09-09-00-681-CF	3
		18	-	22	-	28	32	-	M26x1,5	2	1-S09-11-00-681-CF	4
		22	-	22	-	30	36	-	M30x2	2	1-S09-13-00-681-CF	4
		28	-	24	-	32	41	-	M36x2	2	1-S09-15-00-681-CF	4
S	630	35	-	27	-	42	50	-	M45x2	2	1-S09-17-00-681-CF	4
		42	-	28	-	45	60	-	M52x2	2	1-S09-19-00-681-CF	4
		6	48	-	38	20	17	17	M14x1,5	1	1-S09-00-00-681-CF	3
		8	46	-	38	20	19	17	M16x1,5	1	1-S09-02-00-681-CF	3
	400	10	46	-	40	22	22	17	M18x1,5	1	1-S09-04-00-681-CF	3
		12	46	-	40	22	24	17	M20x1,5	1	1-S09-06-00-681-CF	3
		14	-	20	40	22	27	-	M22x1,5	2	1-S09-08-00-681-CF	3
		16	-	20	-	28	30	-	M24x1,5	2	1-S09-10-00-681-CF	3
		20	-	25	-	30	36	-	M30x2	2	1-S09-12-00-681-CF	4
		25	-	27	-	36	46	-	M36x2	2	1-S09-14-00-681-CF	4
315	30	-	29	-	41	50	-	M42x2	2	1-S09-16-00-681-CF	4	
315	38	-	32	-	48	60	-	M52x2	2	1-S09-18-00-681-CF	4	

For yellow plastic cap **without vibration security**

For metal cap **without vibration security**

Design with sealings made of FKM

replace 680 by 260

replace 680 by 290

replace 10-680 by 12-680 or
00-680 by 02-680

replace 681 by 261

replace 681 by 291

replace 00-681 by 02-681

fitting with test coupling series S12x1,5 – valve function by piston

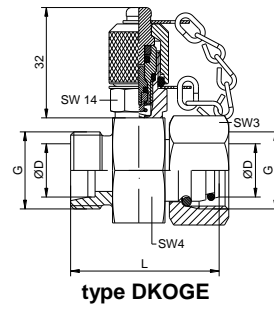
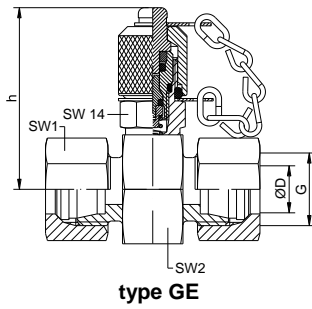

type	PN	tube ØD	G	SW1	SW2	h	L	SW3	SW4	type GE part number	type DKOGE part number
L	315	6	M12x1,5	14	22	43	43	14	24	1-S10-00-00-680-CF	1-S10-20-00-681-CF
		8	M14x1,5	17	24	44	43	17	24	1-S10-02-00-680-CF	1-S10-22-00-681-CF
		10	M16x1,5	19	24	44	45	19	24	1-S10-04-00-680-CF	1-S10-24-00-681-CF
		12	M18x1,5	22	27	45	41	22	27	1-S10-06-00-680-CF	1-S10-26-00-681-CF
		15	M22x1,5	27	30	47	43	27	30	1-S10-09-00-680-CF	1-S10-29-00-681-CF
	160	18	M26x1,5	32	32	48	54	32	32	1-S10-11-00-680-CF	1-S10-31-00-681-CF
		22	M30x2	36	36	50	57	36	36	1-S10-13-00-680-CF	1-S10-33-00-681-CF
		28	M36x2	41	41	52		upon request		1-S10-15-00-680-CF	1-S10-35-00-681-CF
		35	M45x2	50	46	55		upon request		1-S10-17-00-680-CF	1-S10-37-00-681-CF
	42	M52x2	60	55	59		upon request		1-S10-19-00-680-CF	1-S10-39-00-681-CF	
S	630	6	M14x1,5	17	24	44	46	17	24	1-S10-01-00-680-CF	1-S10-21-00-681-CF
		8	M16x1,5	19	24	44	47	19	24	1-S10-03-00-680-CF	1-S10-23-00-681-CF
		10	M18x1,5	22	24	44	48	22	24	1-S10-05-00-680-CF	1-S10-25-00-681-CF
		12	M20x1,5	24	24	44	47	24	24	1-S10-07-00-680-CF	1-S10-27-00-681-CF
		14	M22x1,5	27	27	45	50	27	27	1-S10-08-00-680-CF	1-S10-28-00-681-CF
	400	16	M24x1,5	30	30	47	55	30	30	1-S10-10-00-680-CF	1-S10-30-00-681-CF
		20	M30x2	36	32	48	62	36	36	1-S10-12-00-680-CF	1-S10-32-00-681-CF
		25	M36x2	46	41	52	62	46	41	1-S10-14-00-680-CF	1-S10-34-00-681-CF
		30	M42x2	50	46	55		upon request		1-S10-16-00-680-CF	1-S10-36-00-681-CF
		38	M52x2	60	55	59		upon request		1-S10-18-00-680-CF	1-S10-38-00-681-CF

For yellow plastic cap **without vibration security**

For metal cap **without vibration security**

Design with sealings made of FKM

replace 680 by 260

replace 680 by 290

replace 00-680 by 02-680

replace 681 by 261

replace 681 by 291

replace 00-681 by 02-681

bulkhead coupling series S12x1,5 – valve function by piston

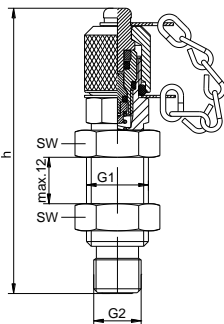

G1	G2	SW	h	part number (NBR)	part number (FKM)
M16x2	S12x1,5	19	74	1-S80-48-68-040-CF	upon request

For yellow plastic cap **without vibration security** replace 68 by

26

26

For metal cap **without vibration security** replace 68 by

29

29

S12x1,5 – connectors and adaptors

bulkhead pressure gauge connector series S12x1,5 – without valve function

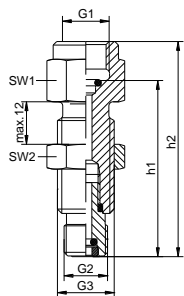

G1	SW1	SW2	h1	h2	G2	sealing	part number (NBR)	part number (FKM)
G 1/4	19	19	50	61	S12x1,5	o-ring	1-918-29-01-430-CF	1-918-29-21-430-CF
G 1/2	27	24	53	70	S12x1,5	o-ring	1-918-31-01-430-CF	1-918-31-21-430-CF
1/4 NPT	19	19	-	62	S12x1,5	thread	1-918-44-00-430-CF	1-918-44-20-430-CF
1/2 NPT	27	24	-	70	S12x1,5	thread	1-918-46-00-430-CF	1-918-46-20-430-CF

For design with damping element replace 918 by

929

929

direct pressure gauge connector series S12x1,5 – without valve function

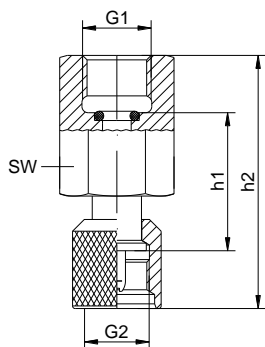

G1	SW	h1	h2	G2	sealing	part number (NBR)	part number (FKM)
G 1/4	19	27	49	S12x1,5	o-ring	1-927-29-01-290-CF	1-927-29-21-290-CF
G 1/2	27	25	53	S12x1,5	o-ring	1-927-31-01-290-CF	1-927-31-21-290-CF
1/4 NPT	19	-	48	S12x1,5	thread	1-927-44-00-290-CF	1-927-44-20-290-CF
1/2 NPT	27	-	54	S12x1,5	thread	1-927-46-00-290-CF	1-927-46-20-290-CF

For design with damping element replace 927 by

929

929

Other dimensions on request. We reserve the right to change the technical performance. All dimensions in mm.

high pressure hose series S12x1,5

Max. working pressure:
up to 630 bar

Pressure / t° factor:
at 20°C 100%
at 40°C 95%
at 60°C 90%
at 80°C 80%
at 100°C 70%

Further details please
see section hoses and
connectors

series S12x1,5

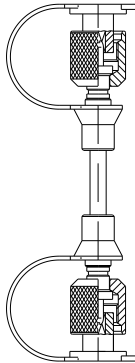

series S12x1,5

series S12x1,5

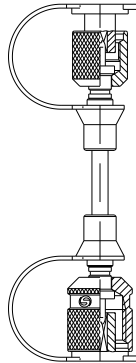

series M16x2

series S12x1,5

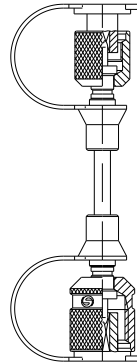

series M16x1,5

series S12x1,5

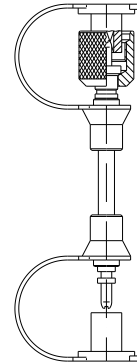

series Steck

series S12x1,5

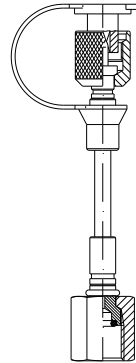

pressure gauge
connector G 1/4 ²⁾

length L ¹⁾ acc. DIN 20066	part number				
200	1-971-12-12-010-CF	1-971-04-12-010-CF	1-971-10-12-010-CF	1-971-01-12-010-CF	1-971-02-12-010-CF
400	1-971-12-12-040-CF	1-971-04-12-040-CF	1-971-10-12-040-CF	1-971-01-12-040-CF	1-971-02-12-040-CF
630	1-971-12-12-060-CF	1-971-04-12-060-CF	1-971-10-12-060-CF	1-971-01-12-060-CF	1-971-02-12-060-CF
800	1-971-12-12-080-CF	1-971-04-12-080-CF	1-971-10-12-080-CF	1-971-01-12-080-CF	1-971-02-12-080-CF
1000	1-971-12-12-090-CF	1-971-04-12-090-CF	1-971-10-12-090-CF	1-971-01-12-090-CF	1-971-02-12-090-CF
1500	1-971-12-12-100-CF	1-971-04-12-100-CF	1-971-10-12-100-CF	1-971-01-12-100-CF	1-971-02-12-100-CF
2000	1-971-12-12-110-CF	1-971-04-12-110-CF	1-971-10-12-110-CF	1-971-01-12-110-CF	1-971-02-12-110-CF
2500	1-971-12-12-120-CF	1-971-04-12-120-CF	1-971-10-12-120-CF	1-971-01-12-120-CF	1-971-02-12-120-CF
3200	1-971-12-12-130-CF	1-971-04-12-130-CF	1-971-10-12-130-CF	1-971-01-12-130-CF	1-971-02-12-130-CF
4000	1-971-12-12-140-CF	1-971-04-12-140-CF	1-971-10-12-140-CF	1-971-01-12-140-CF	1-971-02-12-140-CF

¹⁾ Other lengths upon request

Further connectors please see chapter
hoses and connectors

²⁾ Connection thread G¹/₂,
¹/₄ NPT and ¹/₂ NPT upon request.

The information on the definition of the hose assembly lengths, please see the annex.

hose connector series S12x1,5 – without valve function

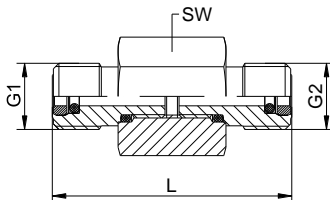

G1	SW	L	G2	part number (NBR)	part number (FKM)
S12x1,5	19	44	S12x1,5	1-980-49-00-010-CF	upon request

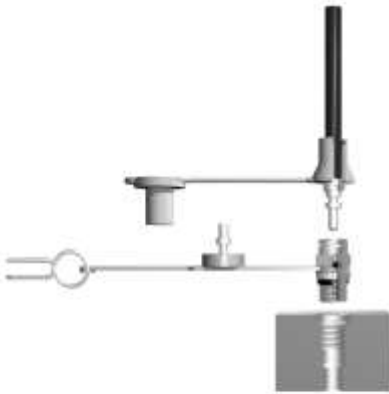

Einsatz:

Spradow test couplings are applied for the monitoring and control pressure as well as the ventilation. The advantages of this system are – among other – connection at system pressure level, the easy connection to measurement control and switching devices, the leakproof connection.

Media:

Hydraulic oils and mineral based fluids.
(Please check compatibility of seal material.)

Materials:

Metal parts: Steel, Stainless steel upon request
Seals: NBR (-20 °C to +100 °C)
FKM (-20 °C to +200 °C)
EPDM (-40 °C to +150 °C)
Hose: polyamide (-35 °C to +100 °C)

Surface:

Zinc nickel, transparent, CrVI-free.

Pressure:

Maximum working pressure (PN) of the test couplings - 400 bar at 3-fold security. For the union pieces please observe the instructions given by the corresponding producer.

port connection and seals

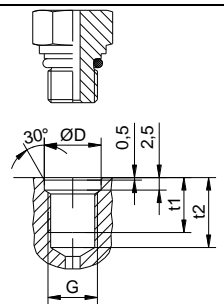
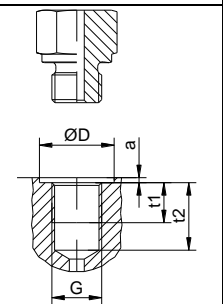
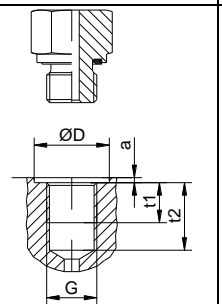
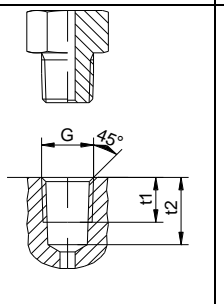
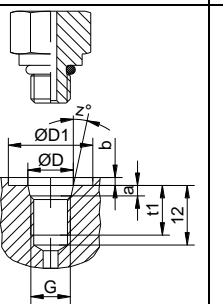
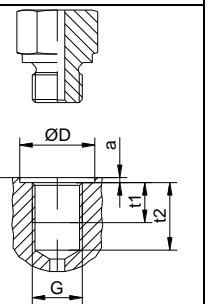
type 1	type 2	type 3	type 4	type 5	type 6
					
Design types of port connection and seals please see annex.					

test coupling series Steck

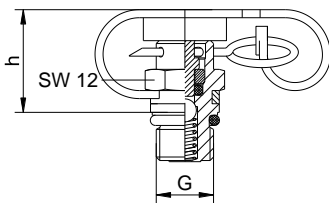

fig. 1

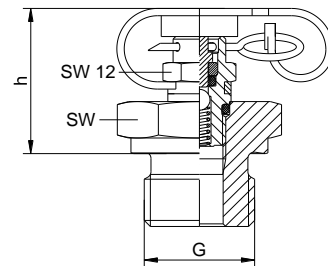

fig. 2

G	PN	SW	h	fig.	sealing	part number (NBR)	part number (FKM)
M8x1	250	-	18	1	o-ring type 1	1-900-20-21-180-CF	1-900-20-22-180-CF
M10x1	400	-	18	1	o-ring type 1	1-900-22-21-180-CF	1-900-22-22-180-CF
Rk 1/8*	400	-	18	1	thread type 4	1-900-33-00-180-CF	1-900-33-02-180-CF
1/8 NPT	-	-	18	1	thread type 4	1-900-43-00-180-CF	1-900-43-02-180-CF
M10x1	-	17	37	2	metallic sealing type 2	1-905-22-30-180-CF	1-905-22-32-180-CF
G 1/4	-	19	27	2	soft sealing type 3	1-905-29-11-180-CF	1-905-29-12-180-CF

*acc. DIN 3858

Other dimensions on request. We reserve the right to change the technical performance. All dimensions in mm.

fitting with test coupling series Steck

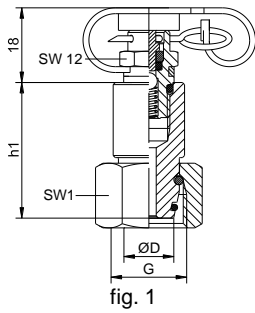

fig. 1

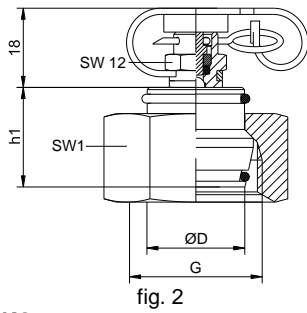

fig. 2

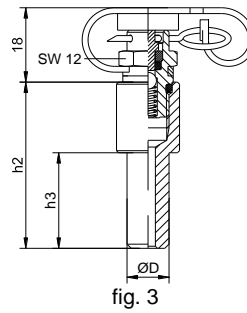

fig. 3

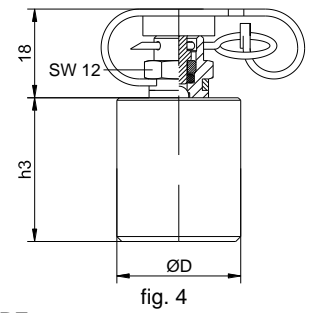

fig. 4

type DKO
test coupling with 24° taper adaptor

type BE
test coupling for compression ring fittings

type	PN	tube ØD	h1	h2	h3	SW1	G	type DKO part number	fig.	type BE part number	fig.
L	315	6	33	38	20	14	M12x1,5	1-902-00-10-180-CF	1	1-903-00-00-181-CF	3
		8	33	38	20	17	M14x1,5	1-902-02-10-180-CF	1	1-903-02-00-181-CF	3
		10	33	40	22	19	M16x1,5	1-902-04-10-180-CF	1	1-903-04-00-181-CF	3
		12	33	40	22	22	M18x1,5	1-902-06-10-180-CF	1	1-903-06-00-181-CF	3
		15	20	-	28	27	M22x1,5	1-902-09-00-180-CF	2	1-903-09-00-181-CF	4
	160	18	22	-	28	32	M26x1,5	1-902-11-00-180-CF	2	1-903-11-00-181-CF	4
		22	22	-	30	36	M30x2	1-902-13-00-180-CF	2	1-903-13-00-181-CF	4
		28	24	-	32	41	M36x2	1-902-15-00-180-CF	2	1-903-15-00-181-CF	4
		35	27	-	42	50	M45x2	1-902-17-00-180-CF	2	1-903-17-00-181-CF	4
		42	28	-	45	60	M52x2	1-902-19-00-180-CF	2	1-903-19-00-181-CF	4
S	400	6	34	38	20	17	M14x1,5	1-902-01-10-180-CF	1	1-903-00-00-181-CF	3
		8	34	38	20	19	M16x1,5	1-902-03-10-180-CF	1	1-903-02-00-181-CF	3
		10	34	40	22	22	M18x1,5	1-902-05-10-180-CF	1	1-903-04-00-181-CF	3
		12	34	40	22	24	M20x1,5	1-902-07-10-180-CF	1	1-903-06-00-181-CF	3
		14	20	40	22	27	M22x1,5	1-902-08-00-180-CF	2	1-903-08-00-181-CF	3
	400	16	20	-	28	30	M24x1,5	1-902-10-00-180-CF	2	1-903-10-00-181-CF	4
		20	25	-	30	36	M30x2	1-902-12-00-180-CF	2	1-903-12-00-181-CF	4
		25	27	-	36	46	M36x2	1-902-14-00-180-CF	2	1-903-14-00-181-CF	4
		30	29	-	41	50	M42x2	1-902-16-00-180-CF	2	1-903-16-00-181-CF	4
		315	38	32	-	48	60	M52x2	1-902-18-00-180-CF	2	1-903-18-00-181-CF

Design with sealings made of FKM

replace 00-180 by 02-180 or
10-180 by 12-180

replace 00-181 by 02-181

90° fitting type BE with test coupling series Steck

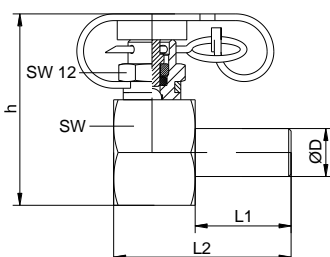

tube ØD	L1	L2	SW	h	part number (NBR)	part number (FKM)
8	20	37	22	40	1-980-03-20-080-CF	1-980-03-20-081-CF
10	20	37	22	40	1-980-05-20-120-CF	1-980-05-20-121-CF

Other dimensions on request. We reserve the right to change the technical performance. All dimensions in mm.

fitting with test coupling series Steck

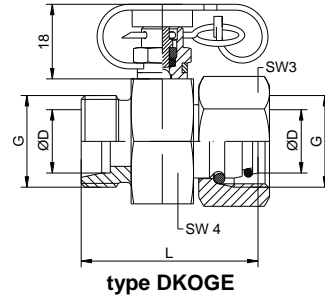
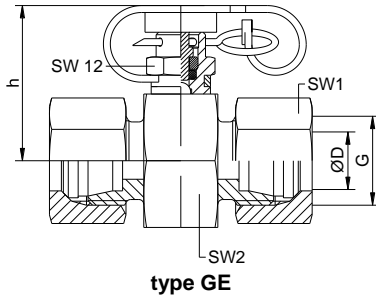

type	PN	tube ØD	G	SW1	SW2	h	L	SW3	SW4	type GE part number	type DKOGE part number
L	315	6	M12x1,5	14	22	29	43	14	24	1-904-00-00-180-CF	1-904-20-00-181-CF
		8	M14x1,5	17	24	30	43	17	24	1-904-02-00-180-CF	1-904-22-00-181-CF
		10	M16x1,5	19	24	30	45	19	24	1-904-04-00-180-CF	1-904-24-00-181-CF
		12	M18x1,5	22	27	32	41	22	27	1-904-06-00-180-CF	1-904-26-00-181-CF
		15	M22x1,5	27	30	33	43	27	30	1-904-09-00-180-CF	1-904-29-00-181-CF
	160	18	M26x1,5	32	32	34	54	32	32	1-904-11-00-180-CF	1-904-31-00-181-CF
		22	M30x2	36	36	36	57	36	36	1-904-13-00-180-CF	1-904-33-00-181-CF
		28	M36x2	41	41	39		upon request		1-904-15-00-180-CF	1-904-35-00-181-CF
		35	M45x2	50	46	41		upon request		1-904-17-00-180-CF	1-904-37-00-181-CF
		42	M52x2	60	55	46		upon request		1-904-19-00-180-CF	1-904-39-00-181-CF
S	630	6	M14x1,5	17	24	30	46	17	24	1-904-01-00-180-CF	1-904-21-00-181-CF
		8	M16x1,5	19	24	30	47	19	24	1-904-03-00-180-CF	1-904-23-00-181-CF
		10	M18x1,5	22	24	30	48	22	24	1-904-05-00-180-CF	1-904-25-00-181-CF
		12	M20x1,5	24	24	30	47	24	24	1-904-07-00-180-CF	1-904-27-00-181-CF
		14	M22x1,5	27	27	32	50	27	27	1-904-08-00-180-CF	1-904-28-00-181-CF
	400	16	M24x1,5	30	30	33	55	30	30	1-904-10-00-180-CF	1-904-30-00-181-CF
		20	M30x2	36	32	34	62	36	36	1-904-12-00-180-CF	1-904-32-00-181-CF
		25	M36x2	46	41	39	62	46	41	1-904-14-00-180-CF	1-904-34-00-181-CF
		30	M42x2	50	46	41		upon request		1-904-16-00-180-CF	1-904-36-00-181-CF
		315	38	M52x2	60	55	46		upon request		1-904-18-00-180-CF

Design with sealings made of FKM replace 00-180 by 02-180 replace 00-181 by 02-181

bulkhead connector series Steck

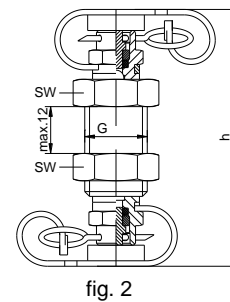
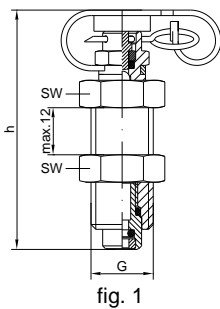

G	SW	h	fig.	part number (NBR)	part number (FKM)
M16x2	19	61	1	1-980-48-20-040-CF	1-980-48-20-041-CF
M16x2	19	71	2	1-980-48-20-050-CF	1-980-48-20-051-CF

Other dimensions on request. We reserve the right to change the technical performance. All dimensions in mm.

bulkhead pressure gauge connector series Steck – without valve function

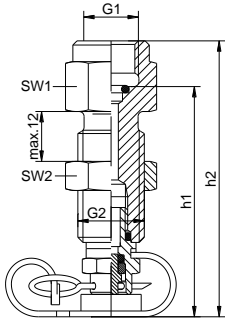

G1	SW1	SW2	h1	h2	G2	sealing	part number (NBR)	part number (FKM)
G 1/4	19	19	55	66	M16x2	o-ring	1-918-29-01-210-CF	1-918-29-21-210-CF
G 1/2	27	24	58	75	M16x2	o-ring	1-918-31-01-210-CF	1-918-31-21-210-CF
1/4 NPT	19	19	-	68	M16x2	thread	1-918-44-00-210-CF	1-918-44-20-210-CF
1/2 NPT	27	24	-	75	M16x2	thread	1-918-46-00-210-CF	1-918-46-20-210-CF

high pressure hose series Steck

Max. working pressure:
up to 630 bar

Pressure / t° factor:
at 20°C 100%
at 40°C 95%
at 60°C 90%
at 80°C 80%
at 100°C 70%

Further details please see
section hoses and con-
nectors

series Steck

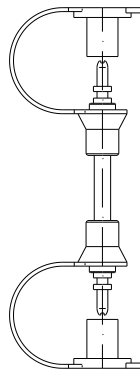

series Steck

series Steck

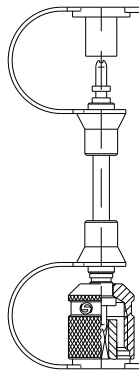

series M16x2

series Steck

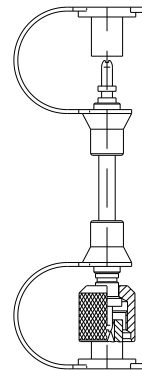

series S12x1,5

series Steck

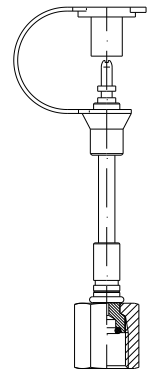

pressure gauge
connector G 1/4²⁾

length L ¹⁾ acc. DIN 20066	part number			
200	1-971-01-01-010-CF	1-971-01-04-010-CF	1-971-01-12-010-CF	1-971-01-02-010-CF
400	1-971-01-01-040-CF	1-971-01-04-040-CF	1-971-01-12-040-CF	1-971-01-02-040-CF
630	1-971-01-01-060-CF	1-971-01-04-060-CF	1-971-01-12-060-CF	1-971-01-02-060-CF
800	1-971-01-01-080-CF	1-971-01-04-080-CF	1-971-01-12-080-CF	1-971-01-02-080-CF
1000	1-971-01-01-090-CF	1-971-01-04-090-CF	1-971-01-12-090-CF	1-971-01-02-090-CF
1500	1-971-01-01-100-CF	1-971-01-04-100-CF	1-971-01-12-100-CF	1-971-01-02-100-CF
2000	1-971-01-01-110-CF	1-971-01-04-110-CF	1-971-01-12-110-CF	1-971-01-02-110-CF
2500	1-971-01-01-120-CF	1-971-01-04-120-CF	1-971-01-12-120-CF	1-971-01-02-120-CF
3200	1-971-01-01-130-CF	1-971-01-04-130-CF	1-971-01-12-130-CF	1-971-01-02-130-CF
4000	1-971-01-01-140-CF	1-971-01-04-140-CF	1-971-01-12-140-CF	1-971-01-02-140-CF

¹⁾ Other lengths upon request

Further connectors please see chapter
hoses and connectors

²⁾ Connection thread G¹/₂,
¹/₄ NPT and ¹/₂ NPT upon request.

The information on the definition of the hose assembly lengths, please see the annex.



The **SPRADOW TEST BOX** is a solid, oil resistant plastic box. It is available either pre-assembled with an assortment of our most popular components or equipped to your specific needs. The pressure gauges, the gauge adapters and the hose are safely nestled in a Plastazote® cushion. Plastazote® is an oil-repellent cross-linked polyethylene foam, which has been especially chosen for this range of application.

The test couplings and reducers of the instant pressure checking equipment are safely and clearly arranged in separate arrays beneath the transparent cover, which can be securely locked. Further arrays are available for your individual requirements.

standard equipment:		STB20FBV-E2-xxx/xxx-CF
pcs	description	
1	Test hose 2000 mm length, M16x2 / M16x2	1-971-04-04-110-CF
1	Pressure gauge Ø 63 mm / G 1/4	1-982-01-01- <u>xxx</u>
1	Pressure gauge Ø 63 mm / G 1/4	1-982-01-01- <u>xxx</u>
1	Pressure gauge connector G 1/4	1-918-29-01-240-CF
1	Direct pressure gauge connector G 1/4	1-927-29-01-020-CF
1	Test coupling G 1/4	1-906-29-11-600-CF
1	Test coupling M 10 x 1	1-906-22-21-600-CF
1	Reducer G 3/8	4-924-03-01-260-CF
1	Reducer G 1/2	4-924-03-01-760-CF

pressure gauge	
order no.	bar
-040	6
-050	10
-060	16
-070	25
-080	40
-090	60
-100	100
-110	160
-120	250
-130	400
-140	600

The content of the SPADOW TEST BOX are adaptable to your specifications.

ORDER EXAMPLE: SPRADOW TEST BOX with 1 pressure gauge 100 bar and 1 pressure gauge 400 bar: **STB20FBV-E2-100/130-CF**



The **SPRADOW TEST BOX** is a solid, oil resistant plastic box. It is available either pre-assembled with an assortment of our most popular components or equipped to your specific needs. The pressure gauges, the gauge adapters and the hose are safely nestled in a Plastazote® cushion. Plastazote® is an oil-repellent cross-linked polyethylene foam, which has been especially chosen for this range of application.

The test couplings and reducers of the instant pressure checking equipment are safely and clearly arranged in separate arrays beneath the transparent cover, which can be securely locked. Further arrays are available for your individual requirements.

standard equipment:		STB20FBV-S6-001-CF (without pressure gauges)
pcs.	description	
1	Test hose 2000 mm length, M16x2 / M16x2	
1	Pressure gauge connector G 1/4	
1	Direct pressure gauge connector G 1/4	
1	Test coupling G 1/4	
1	Test coupling M 10 x 1	
1	Reducer G 3/8	
1	Reducer G 1/2	
up to 6	Pressure gauges to your specifications	

pressure gauge	
order no.	bar
-040	6
-050	10
-060	16
-070	25
-080	40
-090	60
-100	100
-110	160
-120	250
-130	400
-140	600

The content of the SPADOW TEST BOX are adaptable to your specifications.

The SPRADOW TEST BOX is also available for the series M16x2-piston (STB20KFBV-...), M16x1,5-ball (STB15FBV-...), M16x1,5-piston (STB15KFBV-...), S12x1,5 (STB12KFBV-...) and series Steck (STBSTECK-...).

pressure gauge

pressure gauge, glycerine filled, bottom connection, chrome-nickel steel body, scale in bar

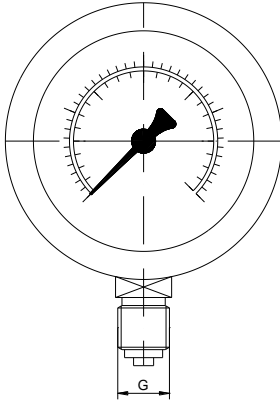

G	pressure stage	nominal size	part number
G 1/4 A	10 bar	63	1-982-01-01-050
G 1/4 A	16 bar	63	1-982-01-01-060
G 1/4 A	25 bar	63	1-982-01-01-070
G 1/4 A	40 bar	63	1-982-01-01-080
G 1/4 A	60 bar	63	1-982-01-01-090
G 1/4 A	100 bar	63	1-982-01-01-100
G 1/4 A	160 bar	63	1-982-01-01-110
G 1/4 A	250 bar	63	1-982-01-01-120
G 1/4 A	400 bar	63	1-982-01-01-130
G 1/4 A	600 bar	63	1-982-01-01-140

pressure gauge, glycerine filled, bottom connection, chrome-nickel steel body, scale in bar/psi

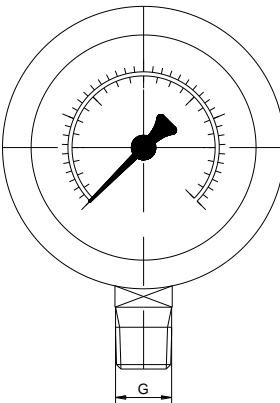

G	pressure stage	nominal size	pressure stage	part number
1/4 NPT	10 bar	63	145 psi	1-982-01-21-050
1/4 NPT	16 bar	63	230 psi	1-982-01-21-060
1/4 NPT	25 bar	63	360 psi	1-982-01-21-070
1/4 NPT	40 bar	63	580 psi	1-982-01-21-080
1/4 NPT	60 bar	63	870 psi	1-982-01-21-090
1/4 NPT	100 bar	63	1450 psi	1-982-01-21-100
1/4 NPT	160 bar	63	2300 psi	1-982-01-21-110
1/4 NPT	250 bar	63	3600 psi	1-982-01-21-120
1/4 NPT	400 bar	63	5800 psi	1-982-01-21-130
1/4 NPT	600 bar	63	8700 psi	1-982-01-21-140

Other dimensions on request. We reserve the right to change the technical performance. All dimensions in mm.

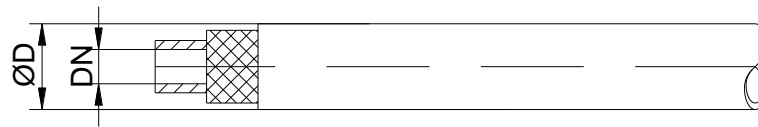

DN	PN	pricked	øD	part no.
2	400 bar	-	5	9-946-02-00-012
2	630 bar	-	5	9-946-02-00-020
2	630 bar	yes	5	9-946-02-01-020

technical data of the hose

nominal diameter	DN 2	DN 2	DN 2
nominal pressure	400 bar	630 bar	630 bar
inner material	Hytrel®	Hytrel®	Hytrel®
reinforcement material	polyester fibre	aramid fibre	aramid fibre
cover material	PA	PA	PA - pricked
max. working pressure	400 bar	630 bar	630 bar
min. bursting pressure	1200 bar	1890 bar	1890 bar
min. bending radius at working pressure	20 mm	20 mm	20 mm
inner diameter	2,1 mm	2,1 mm	2,1 mm
outer diameter	5 mm	5 mm	5 mm
weight / meter	16 g	16 g	16 g
temperature strength	-40 °C to +100 °C*	-40 °C to +100 °C*	-40 °C to +100 °C
number for the type of hose	970	971	975
crimping diameter	7,0 ^{+0,1}	7,0 ^{+0,1}	7,0 ^{+0,1}

*for water and hydrous media up to +70 °C

construction of the SPRADOW order number for hose assemblies

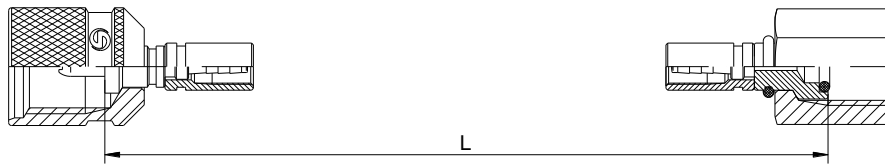

1-971-xx-xx-xxx-CF

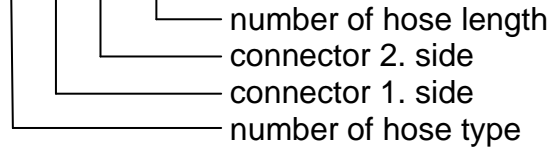

Please take the number for the first and second connector on the following pages.
The lower number of both should be used first.

		number of hose length	
hose length	number for length	hose length	number for length
200 mm	010	800 mm	080
250 mm	020	1000 mm	090
300 mm	030	1500 mm	100
400 mm	040	2000 mm	110
500 mm	050	2500 mm	120
630 mm	060	3200 mm	130
750 mm	070	4000 mm	140

Should you need other length, please use «xxx» as a code on your purchase order or inquiry, putting the desired mm length in brackets. (Example: 1-971-02-04-xxx-CF (5000).)

The information on the definition of the hose assembly lengths, please see the annex.

technical data of the hose fittings

material	steel, 1.0718 (stainless steel upon request)
sealings	NBR (other material upon request)

connectors for hose

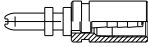
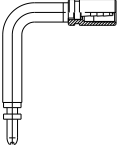
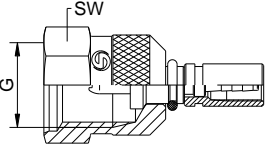
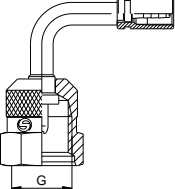
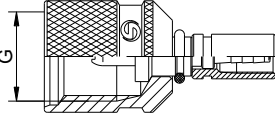
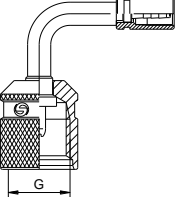
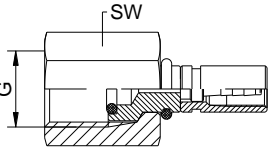
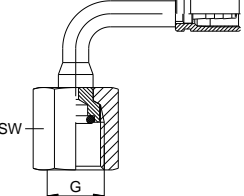
view	Nr.	G	SW / øD	DN	with ferrule	without ferrule	description
	01			2	2-970-01-00-001-CF	2-971-01-00-001-CF	connector for test coupling series: Steck incl. strap
	16			2	2-970-16-00-001-CF	2-971-16-00-001-CF	connector for test coupling series: Steck 90° elbow incl. strap
	03	M16x2	19	2	2-970-03-02-001-CF	2-971-03-02-001-CF	connector for test coupling metal cap type A (universal) incl. strap
	09	M16x1,5	19	2	2-970-09-02-001	2-971-09-02-001	
	0J	M16x2	19	2	2-970-0J-02-001-CF	2-971-0J-02-001-CF	connector for test coupling metal cap type A (universal) 90° elbow incl. strap
	0Z	M16x1,5	19	2	2-970-0Z-02-001	2-971-0Z-02-001	
	04	M16x2		2	2-970-04-02-001-CF	2-971-04-02-001-CF	connector for test coupling metal cap type B (round) incl. strap
	10	M16x1,5		2	2-970-10-02-001	2-971-10-02-001	
	12	S12x1,5		2	2-970-12-02-001-CF	2-971-12-02-001-CF	
	50	M16x2		2	2-970-50-02-001-CF	2-971-50-02-001-CF	connector for test coupling metal cap type B (round) 90° elbow incl. strap
	61	M16x1,5		2	2-970-61-02-001	2-971-61-02-001	
	57	S12x1,5		2	2-970-57-02-001-CF	2-971-57-02-001-CF	
	02	G 1/4	17	2	2-970-02-02-004-CF	2-971-02-02-004-CF	pressure gauge connector with Whitworth - thread sealing to pressure gauge by o-ring
	25	G 1/2	27	2	2-970-25-02-001-CF	2-971-25-02-001-CF	
	58	G 1/4	17	2	2-970-58-02-001-CF	2-971-58-02-001-CF	pressure gauge connector with Whitworth - thread sealing to pressure gauge by o-ring 90° elbow
	54	G 1/2	27	2	2-970-54-02-001-CF	2-971-54-02-001-CF	

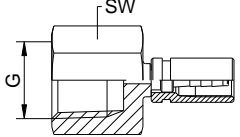
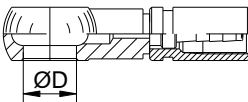
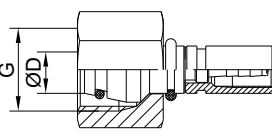
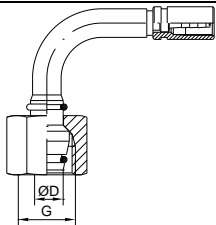
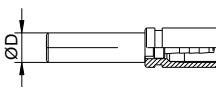
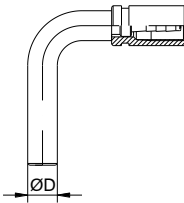
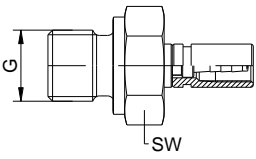
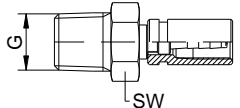

Other dimensions on request. We reserve the right to change the technical performance. All dimensions in mm.

connectors for hose

view	no.	G	SW / \varnothing D	DN	with ferrule	without ferrule	description
	26	1/4 NPT	17	2	2-970-26-00-001-CF	2-971-26-00-001-CF	pressure gauge connector with NPT-thread
	27	1/2 NPT	27	2	2-970-27-00-001-CF	2-971-27-00-001-CF	
	75		8	2	2-970-75-00-001-CF	2-971-75-00-001-CF	ring connection to hollow screw (RGN)
	19	M12x1,5	6L	2	2-970-19-02-001-CF	2-971-19-02-001-CF	seal cone with o-ring and swivel nut for 24° cone fitting (DKO)
20	M14x1,5	6S	2	2-970-20-02-001-CF	2-971-20-02-001-CF		
	21	M14x1,5	8L	2	2-970-21-02-001-CF	2-971-21-02-001-CF	
	22	M16x1,5	8S	2	2-970-22-02-001-CF	2-971-22-02-001-CF	
	23	M16x1,5	10L	2	2-970-23-02-001-CF	2-971-23-02-001-CF	
	24	M18x1,5	10S	2	2-970-24-02-001-CF	2-971-24-02-001-CF	
	44	M12x1,5	6L	2	2-970-44-02-001-CF	2-971-44-02-001-CF	seal cone with o-ring and swivel nut for 24° cone fitting (DKO) 90° elbow
	45	M14x1,5	6S	2	2-970-45-02-001-CF	2-971-45-02-001-CF	
	46	M14x1,5	8L	2	2-970-46-02-001-CF	2-971-46-02-001-CF	
	47	M16x1,5	8S	2	2-970-47-02-001-CF	2-971-47-02-001-CF	
	48	M16x1,5	10L	2	2-970-48-02-001-CF	2-971-48-02-001-CF	
	49	M18x1,5	10S	2	2-970-49-02-001-CF	2-971-49-02-001-CF	
	64		4	2	2-970-64-00-001-CF	2-971-64-00-001-CF	standpipe for use with nut and ring (BE) acc. to DIN 2353
	13		6	2	2-970-13-00-001-CF	2-971-13-00-001-CF	
	15		8	2	2-970-15-00-001-CF	2-971-15-00-001-CF	
	28		6	2	2-970-28-00-001-CF	2-971-28-00-001-CF	standpipe for use with nut and ring (BE) acc. to DIN 2353 90° elbow
	94		8	2	2-970-94-00-001-CF	2-971-94-00-001-CF	
	32	M12x1,5	17	2	2-970-32-00-001-CF	2-971-32-00-001-CF	connector with male thread (AGM/AGR) acc. to DIN 3852
	33	G 1/8 A	14	2	2-970-33-00-001-CF	2-971-33-00-001-CF	
	34	G 1/4 A	19	2	2-970-34-00-001-CF	2-971-34-00-001-CF	
	35	1/8 NPT	12	2	2-970-35-00-001-CF	2-971-35-00-001-CF	connector with male thread (AGN) acc. to ANSI-Norm
	36	1/4 NPT	17	2	2-970-36-00-001-CF	2-971-36-00-001-CF	

Other dimensions on request. We reserve the right to change the technical performance. All dimensions in mm.

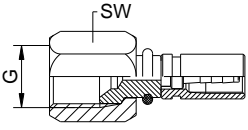
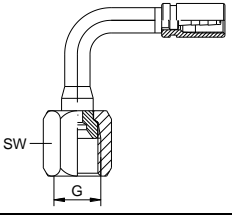
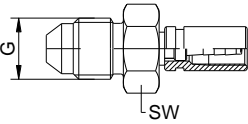
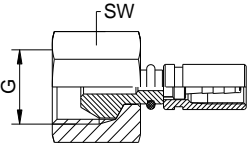
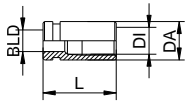
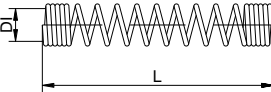
connectors for hose

view	no.	G	SW / øD	DN	with ferrule	without ferrule	description	
	41	7/16 UNF	14	2	2-970-41-02-001-CF	2-971-41-02-001-CF	connector to fit male connection acc. to SAE J514 (DKJ)	
	42	1/2 UNF	17	2	2-970-42-02-001-CF	2-971-42-02-001-CF		
	43	9/16 UNF	19	2	2-970-43-02-001-CF	2-971-43-02-001-CF		
	0K	7/16 UNF	14	2	2-970-0K-02-001-CF	2-971-0K-02-001-CF	connector to fit male connection acc. to SAE J514 (DKJ) 90° elbow	
	1E	9/16 UNF	19	2	2-970-1E-02-001-CF	2-971-1E-02-001-CF		
	37	7/16 UNF	14	2	2-970-37-00-001-CF	2-971-37-00-001-CF	connector with male thread acc. to SAE J514 (AGJ)	
	38	1/2 UNF	17	2	2-970-38-00-001-CF	2-971-38-00-001-CF		
	39	9/16 UNF	19	2	2-970-39-00-001-CF	2-971-39-00-001-CF		
	60	G1/8	14	2	2-970-60-02-001-CF	2-971-60-02-001-CF	connector with 60° cone (DKR) acc. BS5200	
	40	G1/4	17	2	2-970-40-02-001-CF	2-971-40-02-001-CF		
	L	DA	DI	BLD	PM	DN	part no.	ferrule
	15	8	5,6	4,5	7 ^{+0,1}	2	4-999-03-01-160-CF	
	L	DI	DN	part no.	bend protection			
	50	7	2	4-946-00-05-020				
	DN	part no.	strap					
	2	4-934-00-08-170						

Other dimensions on request. We reserve the right to change the technical performance. All dimensions in mm.

standpipe fitting with female thread M10x1

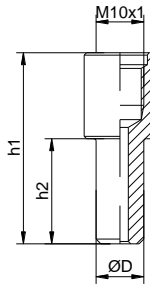

fig. 1

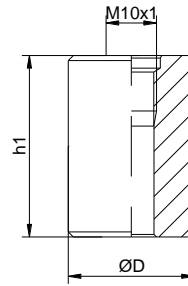
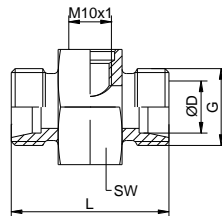

fig. 2

tube ØD	h1	h2	fig.	part number
6	38	20	1	4-922-03-01-430-CF
8	38	20	1	4-922-03-01-440-CF
10	40	22	1	4-922-03-01-450-CF
12	40	22	1	4-922-03-01-460-CF
14	40	22	1	4-922-03-01-470-CF
15	28		2	4-922-03-01-480-CF
16	28		2	4-922-03-01-490-CF
18	28		2	4-922-03-01-500-CF
20	30		2	4-922-03-01-510-CF
22	30		2	4-922-03-01-520-CF
25	36		2	4-922-03-01-530-CF
28	32		2	4-922-03-01-540-CF
30	41		2	4-922-03-01-550-CF
35	42		2	4-922-03-01-560-CF
38	48		2	4-922-03-01-570-CF
42	45		2	4-922-03-01-580-CF

straight fitting with female thread M10x1



type	PN	tube ØD	L	SW	G	type GE without nut and ring part number	type GE with mounted nut and ring part number	
L	315	6	35	22	M12x1,5	2-921-00-00-011-CF	2-921-00-00-010-CF	
		8	35	24	M14x1,5	2-921-00-00-031-CF	2-921-00-00-030-CF	
		10	37	24	M16x1,5	2-921-00-00-051-CF	2-921-00-00-050-CF	
		12	37	27	M18x1,5	2-921-00-00-071-CF	2-921-00-00-070-CF	
		15	39	30	M22x1,5	2-921-00-00-101-CF	2-921-00-00-100-CF	
	18	39	32	M26x1,5	2-921-00-00-121-CF	2-921-00-00-120-CF		
	160	22	43	36	M30x2	2-921-00-00-141-CF	2-921-00-00-140-CF	
		28	43	41	M36x2	2-921-00-00-161-CF	2-921-00-00-160-CF	
		35	47	46	M45x2	2-921-00-00-181-CF	2-921-00-00-180-CF	
42		47	55	M52x2	2-921-00-00-201-CF	2-921-00-00-200-CF		
S	630	6	39	24	M14x1,5	2-921-00-00-021-CF	2-921-00-00-020-CF	
		8	39	24	M16x1,5	2-921-00-00-041-CF	2-921-00-00-040-CF	
		10	39	24	M18x1,5	2-921-00-00-061-CF	2-921-00-00-060-CF	
		12	39	24	M20x1,5	2-921-00-00-081-CF	2-921-00-00-080-CF	
		14	43	27	M22x1,5	2-921-00-00-091-CF	2-921-00-00-090-CF	
	400	16	43	30	M24x1,5	2-921-00-00-111-CF	2-921-00-00-110-CF	
		20	47	32	M30x2	2-921-00-00-131-CF	2-921-00-00-130-CF	
		25	51	41	M36x2	2-921-00-00-151-CF	2-921-00-00-150-CF	
		30	55	46	M42x2	2-921-00-00-171-CF	2-921-00-00-170-CF	
		315	38	61	55	M52x2	2-921-00-00-191-CF	2-921-00-00-190-CF

Other dimensions on request. We reserve the right to change the technical performance. All dimensions in mm.

caps complete with chain / strap

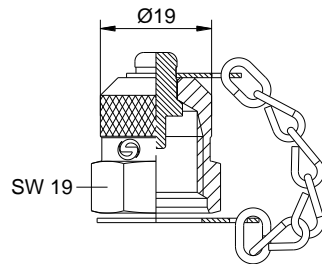

metal cap type A (FA)
fig. 1

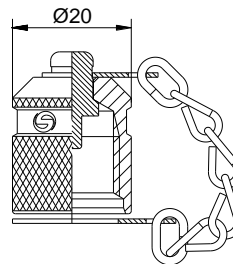

metal cap type B (FB)
fig. 2

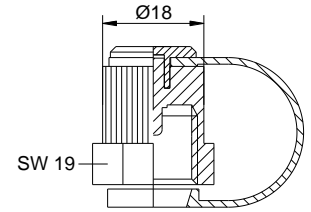

plastic cap (FAK)
fig. 3

G	material	part number (FA)	part number (FB)	part number (FAK)
M16x2	steel	2-910-00-00-560-CF	2-910-00-00-550-CF	-
M16x2	stainless steel	2-910-00-00-600	2-910-00-00-570	-
M16x2	plastic	-	-	2-911-00-00-020
M16x1,5	steel	2-910-00-00-260	2-910-00-00-580	-
M16x1,5	stainless steel	2-910-00-00-590	-	-
M16x1,5	plastic	-	-	2-911-00-00-100
S12x1,5	steel	-	2-910-00-00-620-CF	-
S12x1,5	stainless steel	-	-	-
S12x1,5	plastic	-	-	2-911-00-00-210 (rund)

The caps made from steel and stainless steel are also designed for the use with vibration security.
The vibration security can be ordered with the following numbers.

made from NBR - 6-936-00-06-570

made from FKM - 6-936-00-07-570

plug for series Steck complete with security pin

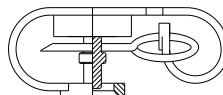

plug for series Steck

G	material	part number
Steck	plastic / steel	2-915-00-00-010-CF

weld-on nozzle

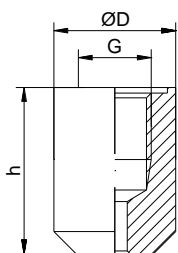

Ø D	h	G	part number	stainless steel part number
22	30	G1/4	4-921-00-01-020	4-921-00-04-020

Other dimensions on request. We reserve the right to change the technical performance. All dimensions in mm.

port connection and seals

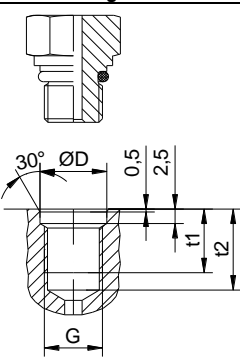
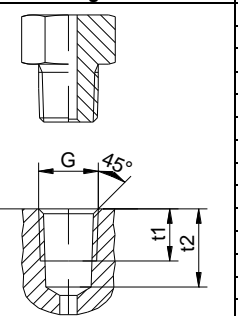
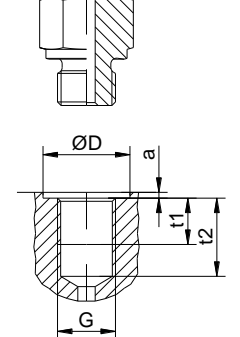
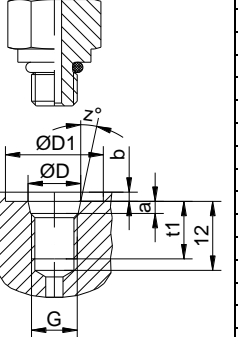
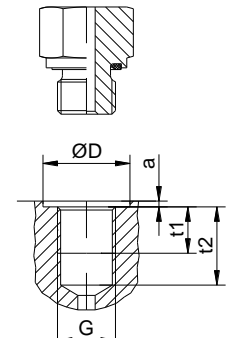
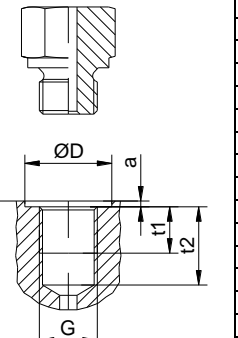
typ	figure	G	øD	a	t1	t2	typ	figure	G	øD1	øD	a	t1	t2	b	Z°				
1		M 8x1	9,5		11	14	4		1/8 NPT				6,9	11,6						
		M 10x1	11,5		11	14			1/4 NPT					10	16,4					
		M 10x1,25	11		10	14			3/8 NPT					10,3	17,6					
									1/2 NPT					13,6	22,6					
									Rk 1/8					5,5	9,5					
					Rk 1/4					8,5	13,5									
					Rk 3/8					8,5	13,5									
Suitable sealant has to be used.																				
2		M 8x1	13	1	8	10	5		5/16-24 UNF	17	9,1	1,9	10	12	1,6	12°				
		M 10 x 1	15	1	8	10			7/16-20 UNF	21	12,4	2,4	11,5	14	1,6	12°				
		M 12 x 1,5	18	1,5	12	15			1/2-20 UNF	23	14	2,4	11,2	14	1,6	12°				
		M 14 x 1,5	20	1,5	12	15			9/16-18 UNF	25	15,7	2,5	12,7	15,5	1,6	12°				
		M 16 x 1,5	23	1,5	12	15			3/4-16 UNF	30	20,6	2,5	14,3	17,5	2,4	15°				
		M 18 x 1,5	25	2	12	15														
		M 20 x 1,5	27	2	14	17														
		M 22 x 1,5	28	2,5	14	17														
		M 26 x 1,5	32	2,5	16	19														
		M 27 x 2	33	2,5	16	20														
		M 33 x 2	40	2,5	18	22														
		M 42 x 2	50	2,5	20	24														
		M 48 x 2	56	2,5	22	26														
3		M 10 x 1	15	1	8	10	6		M10x1		15	1	8	10						
		M 10x1,25	18	1,5	10	15			G1/4		20	1,5	12	15,5						
		M 12 x 1,5	18	1,5	12	15														
		M 14 x 1,5	20	1,5	12	15														
		M 16 x 1,5	23	1,5	12	15														
		M 18 x 1,5	25	2	12	15														
		M 20 x 1,5	27	2	14	17														
		M 22 x 1,5	28	2,5	14	17														
		M 26 x 1,5	32	2,5	16	19														
		M 27 x 2	33	2,5	16	20														
		M 33 x 2	40	2,5	18	22														
		M 42 x 2	50	2,5	20	24														
		M 48 x 2	56	2,5	22	26														

definition of the hose assembly length

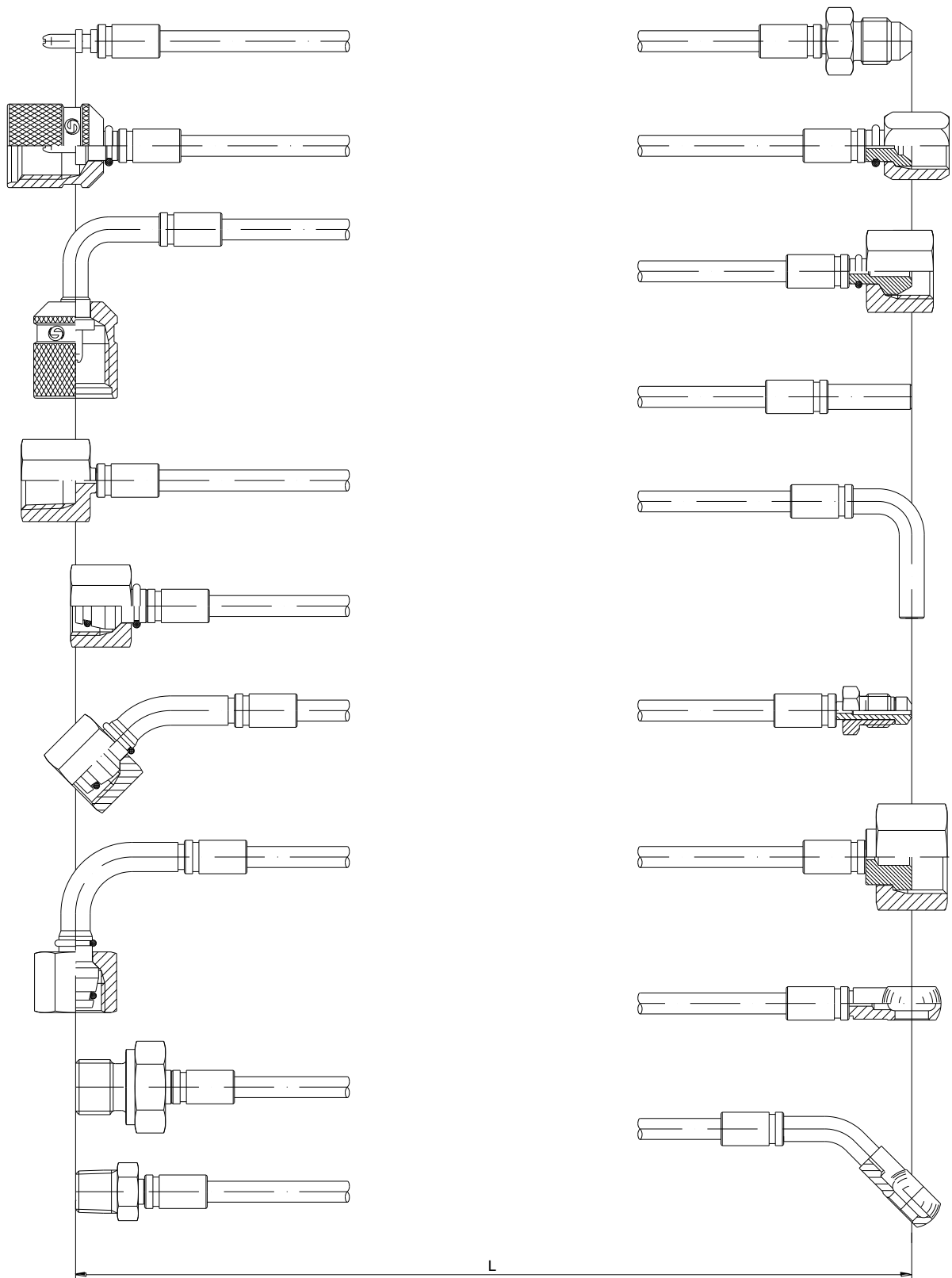

definition of the hose assembly length according DIN 20066

Other dimensions on request. We reserve the right to change the technical performance. All dimensions in mm.